



# MEAX-LGI-SMA

5GNR, Iridium and GNSS Screw Mount

Part #: 189-00065-01

## Description

The MEA-LGI-SMA Screw Mount Antenna is a 3-in-1 low profile antenna solution, with a very high-performance ideal for maintaining constant network connectivity. The MEA-LGI-SMA covers all 5GNR, Iridium and GPS/GLONASS/QZSS/Galileo standard frequencies. This is an ideal antenna for telematics systems, remote surveillance, asset tracking and any IOT system applications. The high performance and low profile make this antenna ideal for the most challenging installations. This screw mount antenna is easy to install with maximum durability offering IP67 rated housing and anti-rotation mounting. The MEA-LGI-SMA has a three cables with a SMA-Male standard connectors, 2m standard cable length and is fully customizable by offering additional connector types, cable lengths and cable types.



Cable 1 - 5GNR Antenna	
Technology	5G, 4G, 3G and 2G
Frequency Range	617-960 MHz
Return Loss	-8.9 dB
VSWR	2.6:1
Efficiency	55.0%
Peak Gain	2.3 dBi
Average Gain	-2.7 dB
Frequency Range	1427-2690 MHz
Return Loss	-9.2 dB
VSWR	2.4:1
Efficiency	51.2%
Peak Gain	5.1 dBi
Average Gain	-3.1 dB
Frequency Range	3300-5000 MHz
Return Loss	-8.2
VSWR	2.7:1
Efficiency	25.7%
Peak Gain	2.6 dBi
Average Gain	-6.7 dB
Frequency Range	5150-5925 MHz
Return Loss	-7.5 dB
VSWR	2.5:1
Efficiency	28.3%
Peak Gain	2.7dBi
Average Gain	-5.5 dB
Impedance	50 Ohm
Polarization	Linear
Radiation Pattern	Omni-Directional
Max. Input Power	25 W

## Features

- 3in1 antenna: 5GNR, Iridium and GNSS
- Ultra-Wide band antenna
- High performance
- Easy mounting: Screw Mount
- Optimized for Iridium network
- Anti-Rotation Mounting
- Ground Plane Independent
- Customizable Cable and Connector
- Low profile 80 × 74 × 25.6 mm
- IP67
- IP69

## Applications

- IoT applications
- Telematic
- Navigation
- Satellite Communications
- LTE applications

**Table 2 - Iridium Antenna**

Frequency Range	1616 - 1627 MHz
Band	Iridium
Return Loss	-12.5 dB
VSWR	1.6:1
Efficiency	68.1%
Peak Gain	5.2 dBic
Average Gain	-1.8 dB
Radiation Pattern	Hemispherical
Polarization	RHCP

**Table 3 - GNSS Ceramic Active Antenna**

Frequency Range	1559 - 1608 MHz
Band	GPS/GLONASS/QZSS/Galileo
Return Loss	≤ -15 dB
VSWR	1.4:1
Efficiency	68.1%
Impedance	50 Ohms
Active Gain	28 dB @ 2.7 V
Radiation Pattern	Hemispherical
Polarization	RHCP
Saw Filter Type	Pre-filter
Noise Figure	1.5 dB Typ
Voltage	1.5 – 3.6 V
Current Consumption	9 mA Typ
Power Consumption	24.3 mW Typ
ESD Protection	2kV

**Mechanical Specifications**

Antenna Dimensions	80 x 74 x 25.6 mm
Operating Temperature	-40 °C to +85 °C
Certificates	Iridium Certified, IP67, IP69
Connector	SMA male
Antenna Color	Black, White
Radome Type	PC + ASA
Substance Compliance	RoHS
Cable Length	200 cm
Mounting style	Screw mount
Max. Tighten Torque	5 Nm

\*Antenna Measurement Conditions:  
Mounted on metal plate of 30x30cm

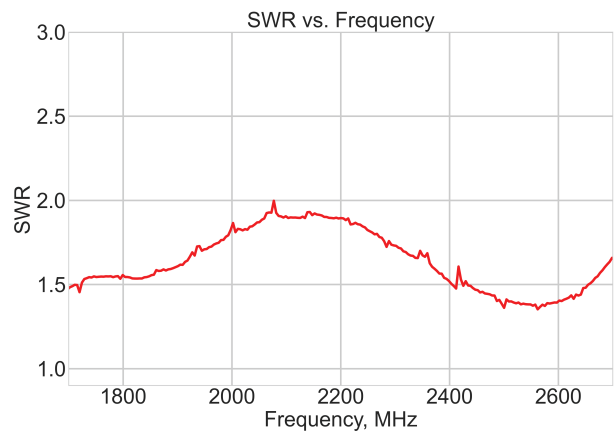
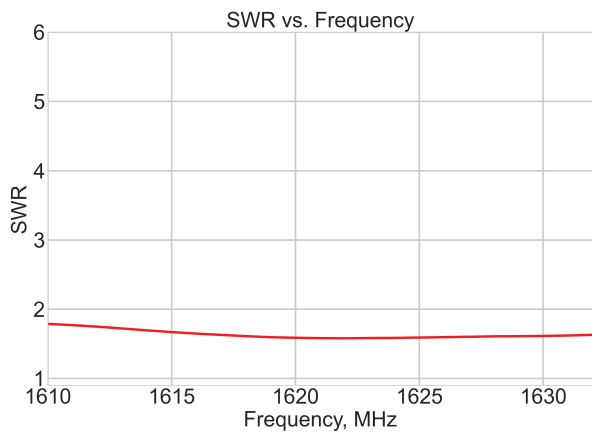
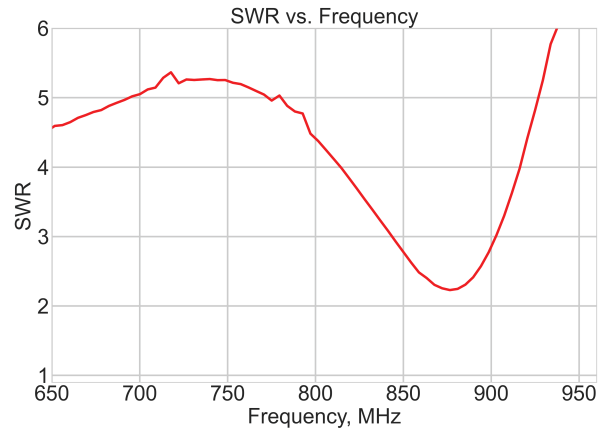
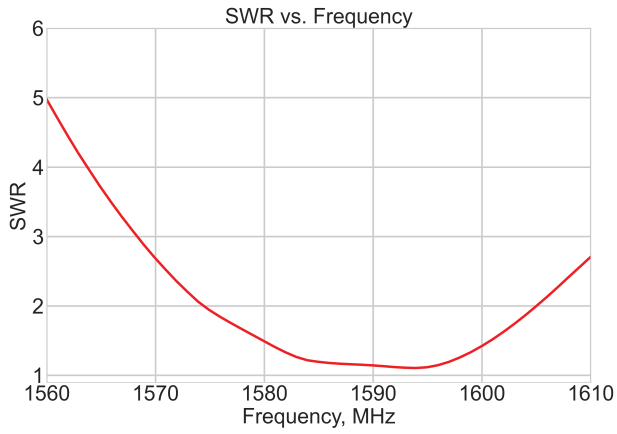

Maxtena Inc.  
 7361 Calhoun Place, Suite 102  
 Rockville, MD 20855  
 1-877-629-8362  
 info@maxtena.com  
 www.maxtena.com

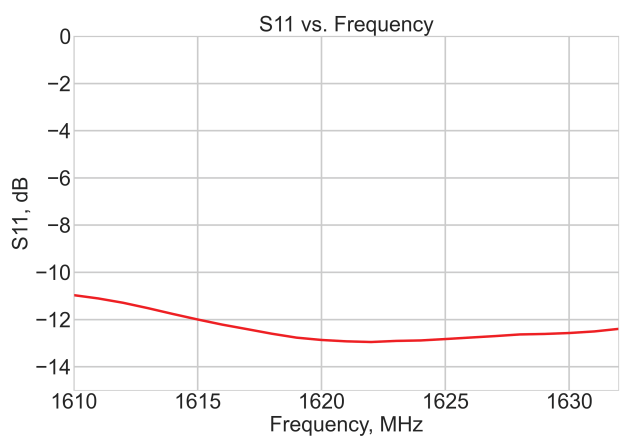
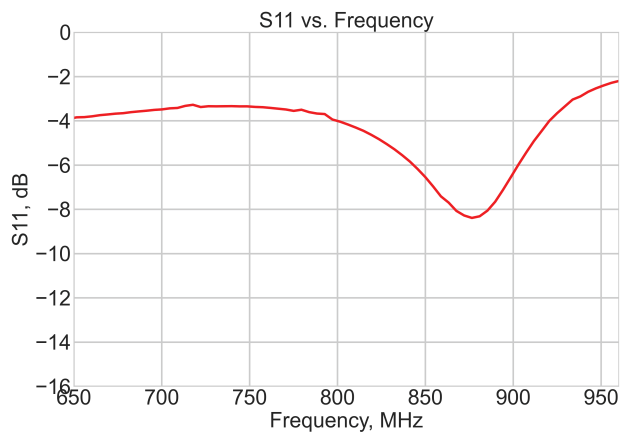
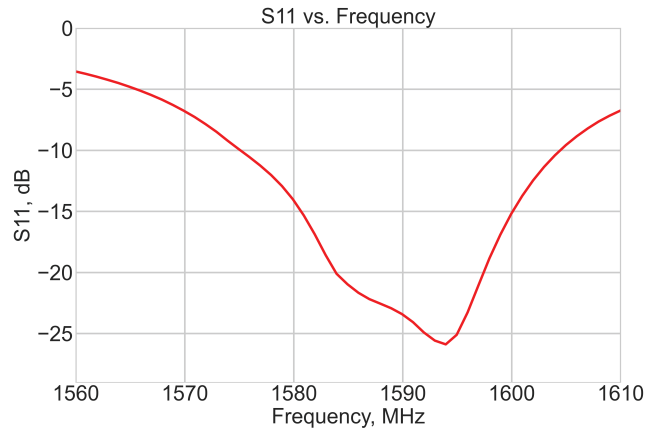
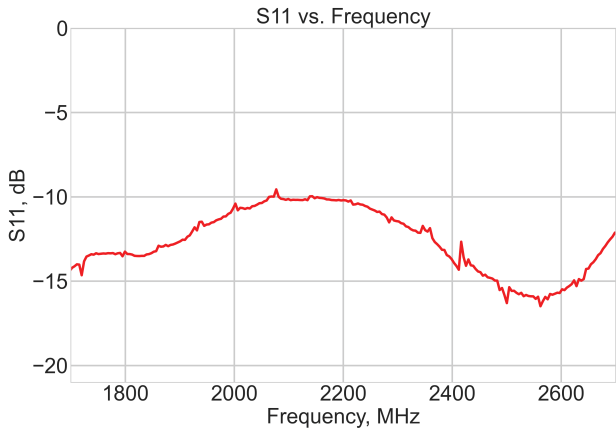

DRAWING REVISION HISTORY			
REV	DESCRIPTION	DATE	BY
A	INITIAL RELEASE	2021-03-17	QZ

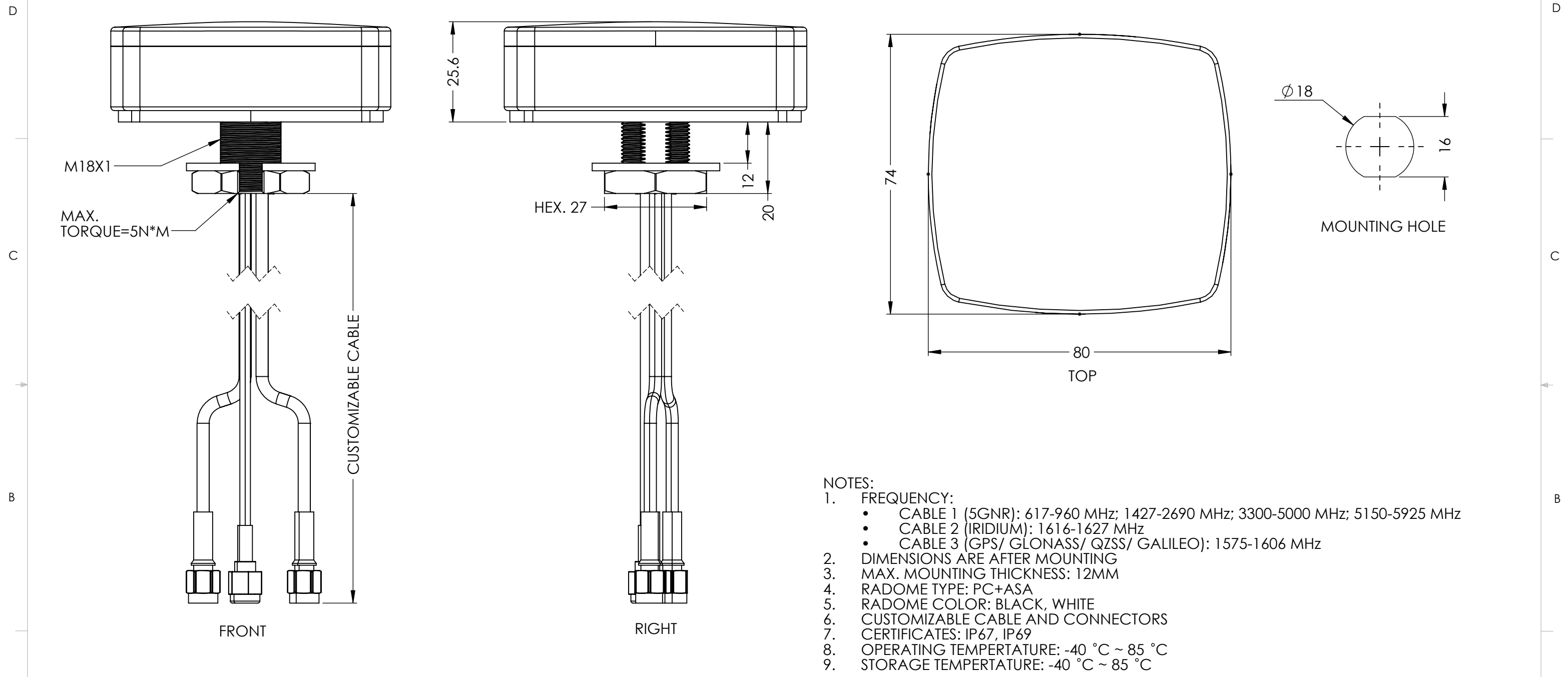

- NOTES:
- FREQUENCY:
    - CABLE 1 (5G NR): 617-960 MHz; 1427-2690 MHz; 3300-5000 MHz; 5150-5925 MHz
    - CABLE 2 (IRIDIUM): 1616-1627 MHz
    - CABLE 3 (GPS/ GLONASS/ QZSS/ GALILEO): 1575-1606 MHz
  - DIMENSIONS ARE AFTER MOUNTING
  - MAX. MOUNTING THICKNESS: 12MM
  - RADOME TYPE: PC+ASA
  - RADOME COLOR: BLACK, WHITE
  - CUSTOMIZABLE CABLE AND CONNECTORS
  - CERTIFICATES: IP67, IP69
  - OPERATING TEMPERATURE: -40 °C ~ 85 °C
  - STORAGE TEMPERATURE: -40 °C ~ 85 °C

ITEM 189-00065 REVISION HISTORY			
REV	DESCRIPTION	DATE	BY
A	INITIAL RELEASE	2021-03-17	QZ

189-00065 CONFIGURATION TABLE			
DASH NO	RADOME COLOR	CABLE & LENGTH	CONNECTOR TYPE
-01	BLACK	CABLE 1 : D302,2M; CABLE 2 : D302,2M; CABLE 3 : D100,2M	SMA MALE

UNLESS OTHERWISE SPECIFIED:

DIMENSIONS ARE IN MM  
TOLERANCES:  
FRACTIONAL: ±  
ANGULAR: MACH ± .5° BEND ±  
INTEGER ± 2  
ONE PLACE DECIMAL ± 1.0  
TWO PLACE DECIMAL ± .50  
INTERPRET GEOMETRIC TOLERANCING PER:

THIRD ANGLE PROJECTION  
DO NOT SCALE DRAWING

CAD MAINTAINED. CHANGES SHALL BE INCORPORATED BY THE DESIGN ACTIVITY.

MAXTENA, INC

TITLE: 189-00065 MEA-LGI-SMA

SIZE B DWG. NO. 117-00463-01 REV A

CAGE CODE: 5KQH7 SCALE: NONE SHEET 1 OF 1

PROPRIETARY AND CONFIDENTIAL  
THE INFORMATION CONTAINED IN THIS DRAWING IS THE SOLE PROPERTY OF MAXTENA, INC. ANY REPRODUCTION IN PART OR AS A WHOLE WITHOUT THE WRITTEN PERMISSION OF MAXTENA, INC IS PROHIBITED.