



# MEA-5G-ISM-MIMO-GNSS

5G NR MIMO, 2.4/5.0 GHz ISM, and GNSS Screw Mount

Part #: 100-00240-01

## Description

The MEA-5G-ISM-MIMO-GNSS is a MIMO technology solution by Maxtena that combines a 5G antenna, and ISM with GNSS. Our 4 in 1 solution is ideal for high data throughput and streaming, video, industrial and IOT applications. It offers a low profile design with easy mounting and integrated SMA connectors. The antenna is designed with rugged PC+ABS plastic black housing and is ideal for the most demanding environmental challenges.

This screw mount antenna is easy to install with maximum durability. The MEA-5G-ISM-MIMO-GNSS has four cables with a SMA-Male standard connector, 3m standard cable length and is fully customizable by offering additional connector types, cable lengths and cable types.

## Electrical Specifications

Cable 1 - 5G NR Antenna

Parameter	Specification			
Technologies	5G, 4G, 3G and 2G			
Standards	5G NR/4GLTE/FirstNet/CBRS/LPWA/CAT-X/CAT-Mx/CAT-NBx/NB-IoT/3G/2G			
Frequency (MHz)	617-960	1427-2690	3300-5000	5150-5925
Return Loss (dB)	~ -8.2	~ -16.3	~ -17.9	~ -18.9
VSWR	~ 2.5:1	~ 1.4:1	~ 1.4:1	~ 1.3:1
Efficiency (%)	~ 38.5	~ 45.8	~ 41.6	~ 36.6
Peak Gain (dB)	~ 0.3	~ 3.6	~ 4.7	~ 3.8
Average Gain (dB)	~ -4.2	~ -3.4	~ -3.8	~ -4.4
Impedance (Ω)	50			
Polarization	Linear			
Radiation Pattern	Omni-Directional			
Max Input Power (W)	35			
Connector Type	SMA-Male (other connectors available)			
Cable Length	300 cm (custom length available)			
Cable Type	LL195 (other cable type available)			

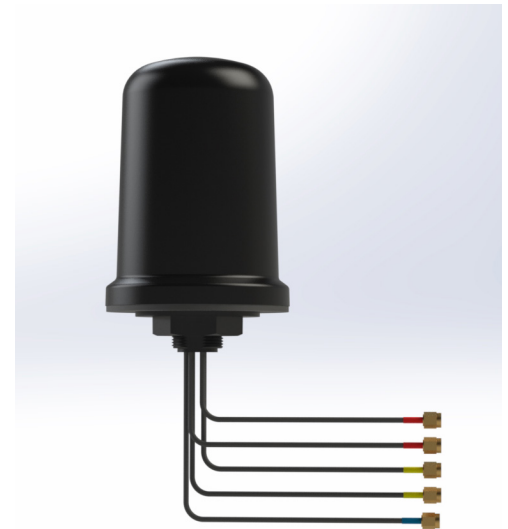

## Features

- 5G NR , 2.4/5.0 GHz ISM /GPS/ GLONASS/QZSS/Galileo - 1575-1606 MHz frequency coverage
- Easy mounting: screw mount
- Heavy duty antenna
- High performance
- Ground plane independent
- Anti-rotation mounting
- Customizable cable and connector
- Dimensions: Ø 96 x H 130 mm
- IP67
- IP69
- IK09

## Applications

- Fleet management
- Commercial transport
- HD video monitoring
- Buses, train & commercial applications
- Smart cities

Cable 2 - 5G NR Antenna

Parameter	Specification			
Technologies	5G, 4G, 3G and 2G			
Standards	5G NR/4G LTE/FirstNet/CBRS/LPWA/CAT-X/CAT-Mx/CAT-NBx/NB-IoT/3G/2G			
Frequency (MHz)	617-960	1427-2690	3300-5000	5150-5925
Return Loss (dB)	~ -8.2	~ -15.6	~ -13.7	~ -13.2
VSWR	~ 2.5:1	~ 1.4:1	~ 1.7:1	~ 1.9:1
Efficiency (%)	~ 42.2	~ 45.3	~ 43.0	~ 36.7
Peak Gain (dB)	~ 0.7	~ 3.7	~ 4.6	~ 3.6
Average Gain (dB)	~ -3.8	~ -3.5	~ -3.7	~ -4.4
Impedance ( $\Omega$ )	50			
Polarization	Linear			
Radiation Pattern	Omni-Directional			
Max Input Power (W)	35			
Connector Type	SMA-Male (other connectors available)			
Cable Length	300 cm (custom length available)			
Cable Type	LL195 (other cable type available)			

Cable 3 - 2.4/5.0 GHz ISM Antenna

Parameter	Specification	
Standards	WiFi, BT, ZigBee, ISM	
Band (MHz)	2.4 GHz	5.0 GHz
Frequency (MHz)	2410-2490	4920-5925
Return Loss (dB)	~ -13.7	~ -17.3
VSWR	~ 1.5:1	~ 1.4:1
Efficiency (%)	~ 43.4	~ 26.2
Peak Gain (dB)	~ 5.3	~ 1.5
Average Gain (dB)	~ -3.6	~ -5.9
Impedance ( $\Omega$ )	50	
Polarization	Linear	
Radiation Pattern	Omni-Directional	
Max Input Power (W)	25	
Connector Type	SMA-Male (other connectors available)	
Cable Length	300 cm (custom length available)	
Cable Type	LL195 (other cable type available)	

Cable 4 - 2.4/5.0 GHz ISM Antenna

Parameter	Specification	
Standards	WiFi, BT, ZigBee, ISM	
Band (MHz)	2.4 GHz	5.0 GHz
Frequency (MHz)	2410-2490	4920-5925
Return Loss (dB)	~ -13.3	~ -18.4
VSWR	~ 1.6:1	~ 1.3:1
Efficiency (%)	~ 41.8	~ 30.9
Peak Gain (dB)	~ 5.3	~ 2.3
Average Gain (dB)	~ -3.8	~ -5.2
Impedance ( $\Omega$ )	50	
Polarization	Linear	
Radiation Pattern	Omni-Directional	
Max Input Power (W)	25	
Connector Type	SMA-Male (other connectors available)	
Cable Length	300 cm (custom length available)	
Cable Type	LL195 (other cable type available)	

Cable 5 - GPS/GLONASS Antenna

Parameter	Specification	
Standards	GPS/QZSS/Galileo	GLONASS
Band (MHz)	1575	1602
Frequency (MHz)	1575.42	1598-1610
Return Loss (dB)	<= -14	
VSWR	<= 1.5:1	
Impedance ( $\Omega$ )	50	
Polarization	RHCP	
Radiation Pattern	Hemispherical	
Saw Filter	Post-Filter	
Active Gain (dB)	23 @ 3 V, 24 @ 5 V	
Noise Figure (dB)	1.2	
Voltage (V)	2.7 - 5.5	
Current Consumption (mA)	15 - 25	
Power Consumption (mW)	40.5 - 137.5	
Out of Band Rejection (dBc)	~ 32	
Connector Type	SMA-Male (other connectors available)	
Cable Length	300 cm (custom length available)	
Cable Type	LL100 (other cable type available)	

**Antenna Measurement Conditions:**

Mounted on metal plate of 30 x 30 cm  
 200 cm of cable LL195  
 Measured in certified CTIA 3D anechoic chamber

## Mechanical and Environmental Specifications

Parameter	Specification
Mounting Type	Screw Mount
Dimensions (mm)	Ø 96 X H 130
Max. Tighten Torque (Nm)	6 Nm
Radome	ASA
Radome Color	White, Black
Antenna Base	Alluminium alloy
Operating Temperature (C)	-40 to +85°
Storage Temperature (C)	-40 to +85°
Protection	IP67, IP69K, IK09
Substance Compliance	RoHS

Radiation Performance  
MEA-5G-ISM-MIMO-GNSS

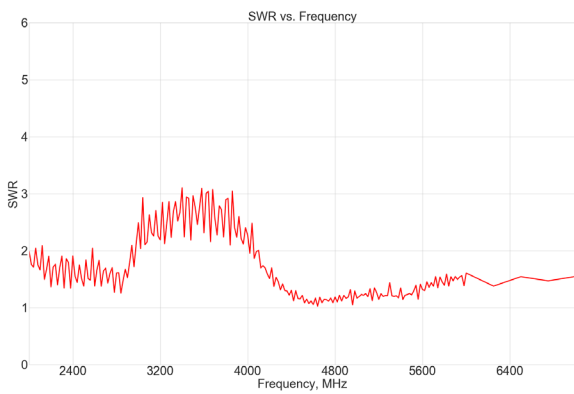
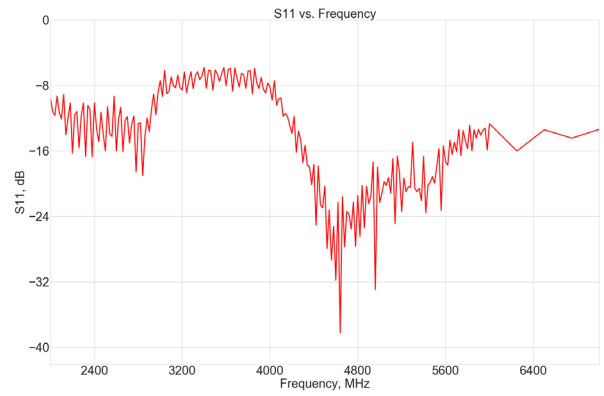
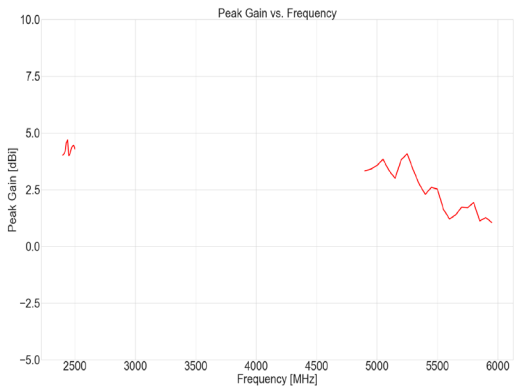
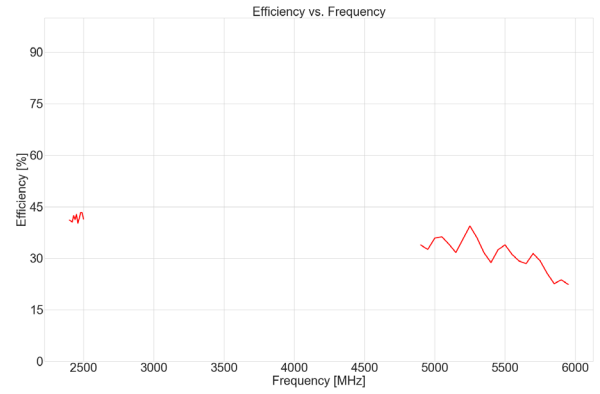
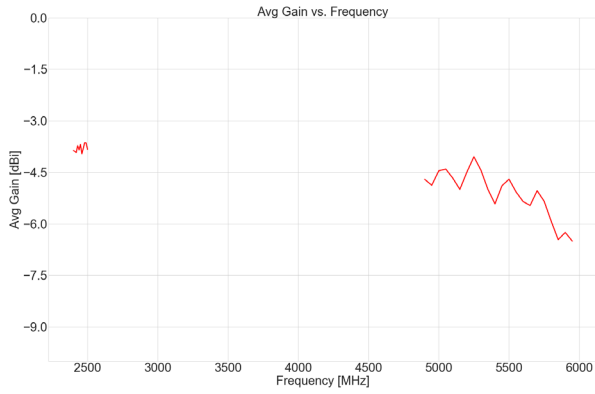

# Radiation Performance

## MEA-5G-ISM-MIMO-GNSS

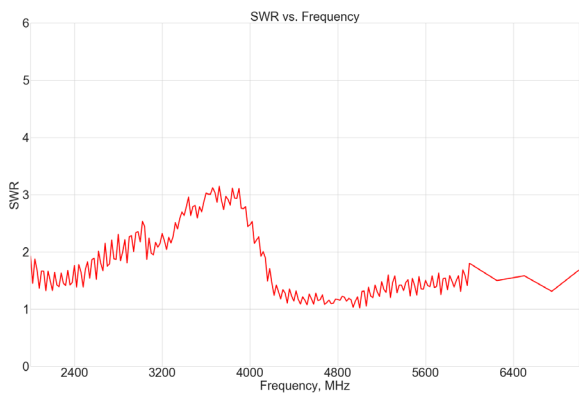
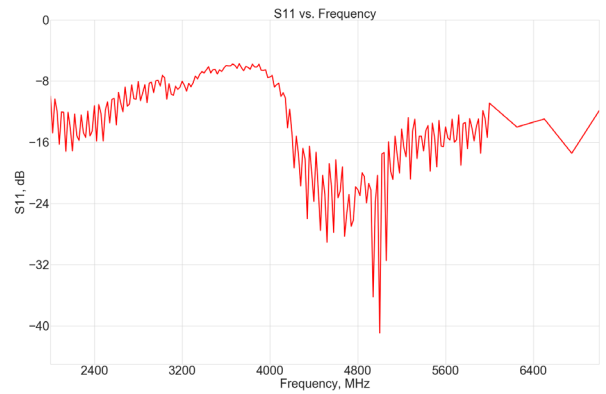
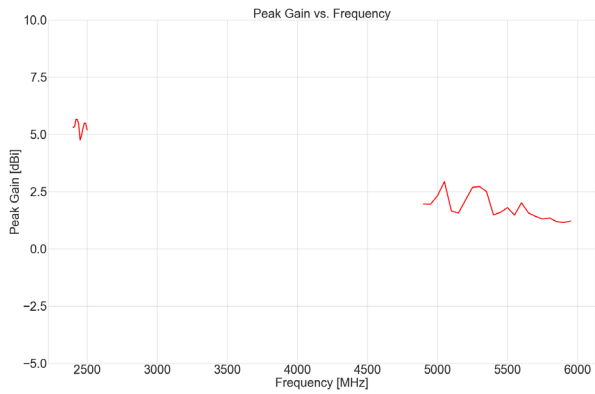
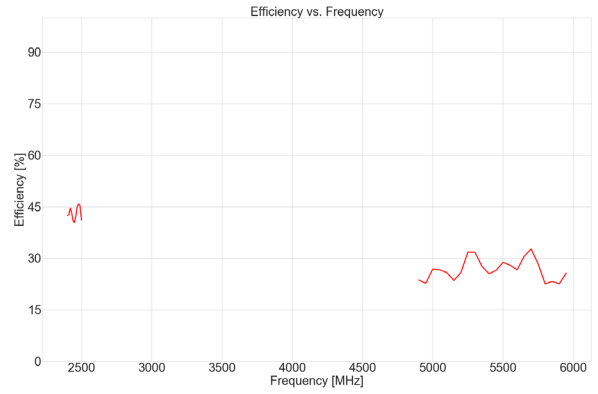
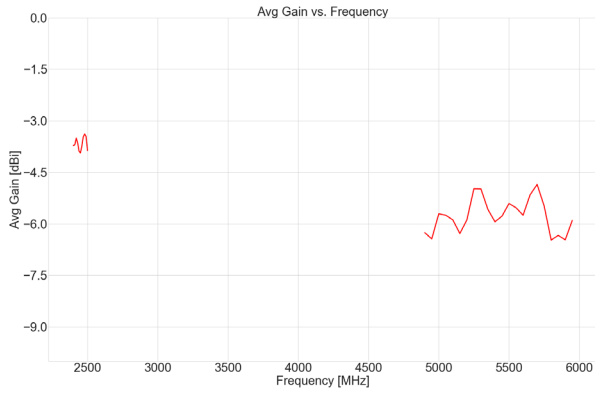

Radiation Performance  
MEA-5G-ISM-MIMO-GNSS

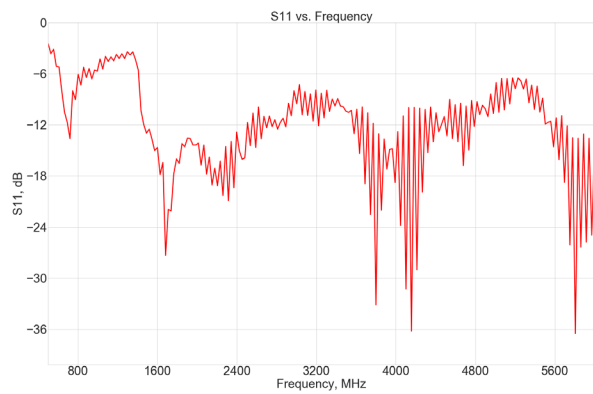
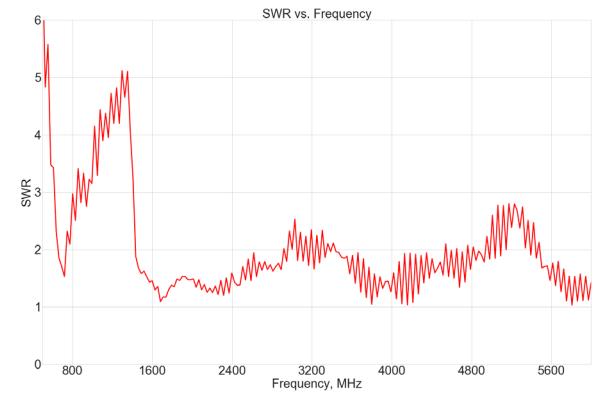
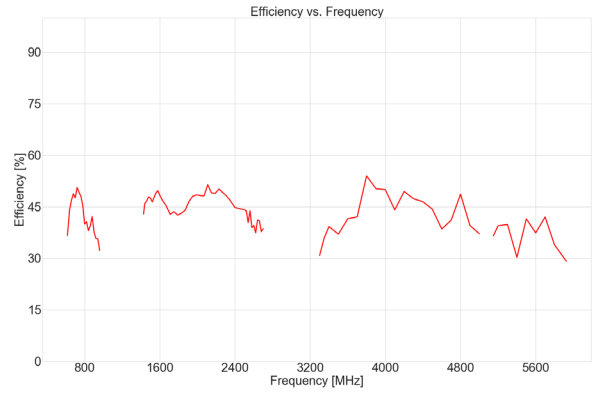
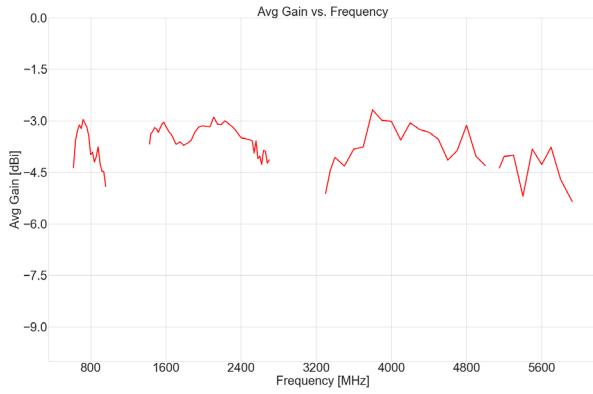

# Radiation Performance

## MEA-5G-ISM-MIMO-GNSS

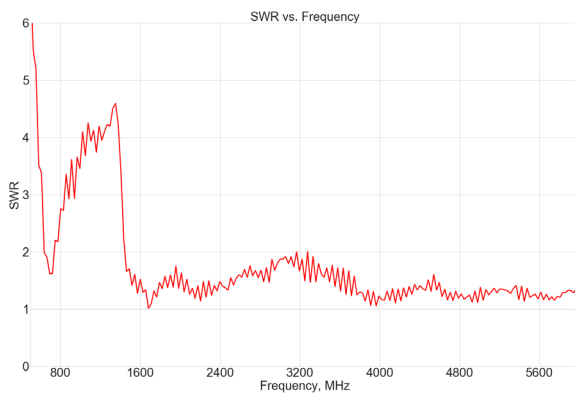
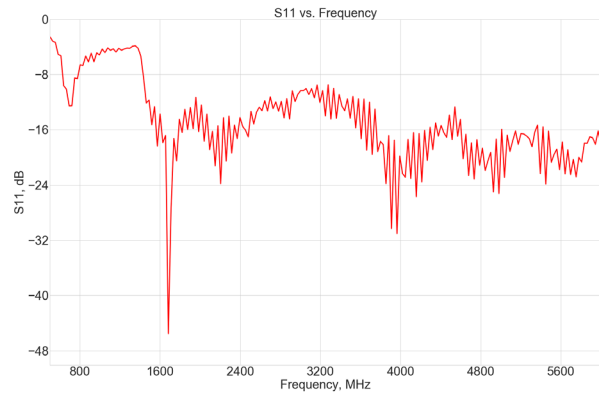
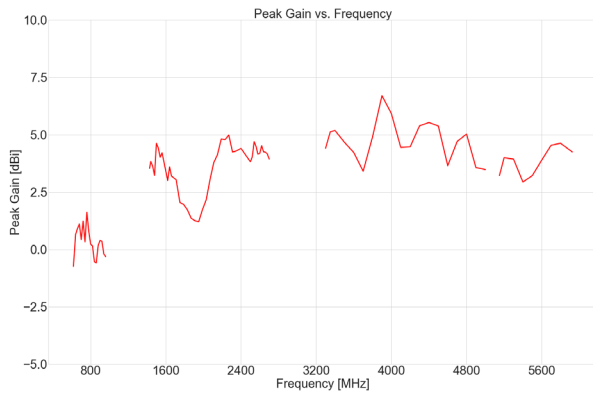
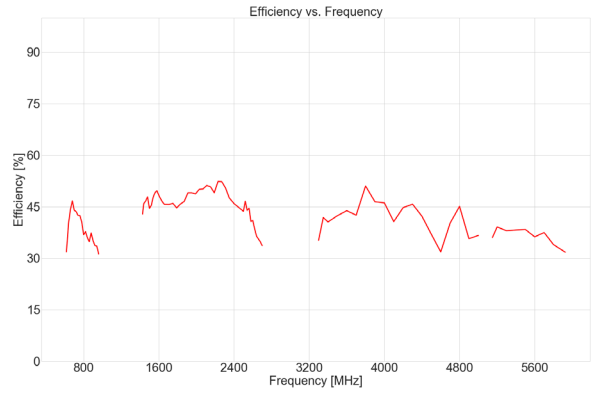
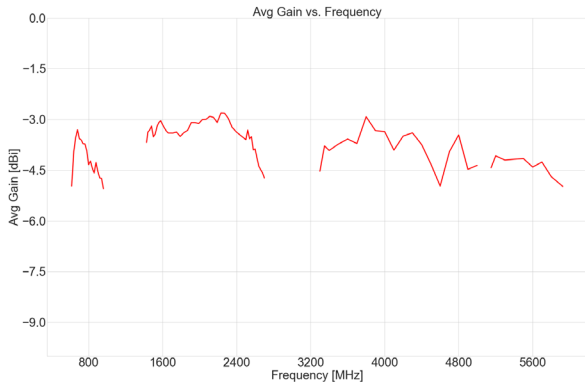



DRAWING REVISION HISTORY			
REV	DESCRIPTION	DATE	BY
A	INITIAL RELEASE	2022-01-28	JET

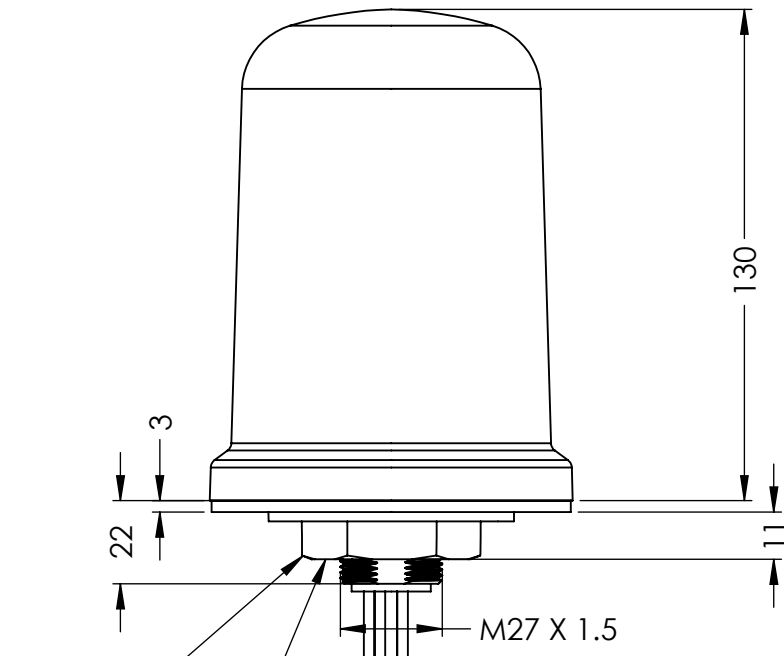
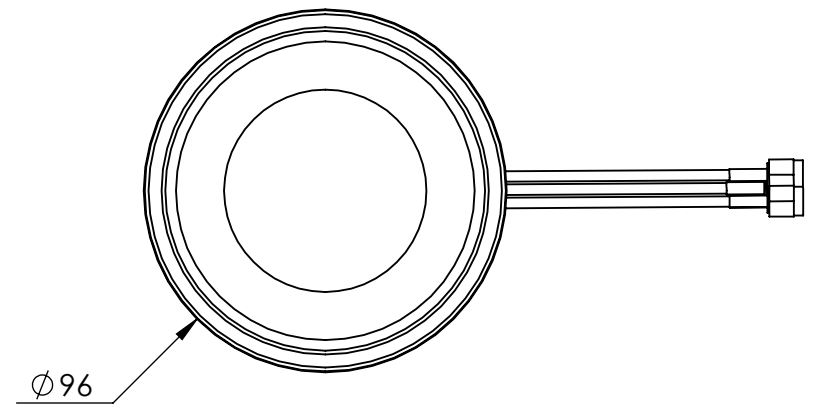

- NOTES:
- FREQUENCY:
    - CABLE 1: 617-960 MHz, 1427-2690 MHz, 3300-5000 MHz, 5150-5925 MHz
    - CABLE 2: 617-960 MHz, 1427-2690 MHz, 3300-5000 MHz, 5150-5925 MHz
    - CABLE 3: 2410-2490 MHz, 4920-5925 MHz
    - CABLE 4: 2410-2490 MHz, 4920-5925 MHz
    - CABLE 5: 1575.42 MHz, 1598-1610 MHz
  - DIMENSIONS ARE AFTER MOUNTING
  - CUSTOMIZABLE CABLE AND CONNECTOR TYPE
  - MOUNTING TYPE: SCREW MOUNT
  - MAX. MOUNTING THICKNESS: 8mm
  - MATERIALS:
    - RADOME: ASA
    - RADOME COLOR: BLACK or WHITE
    - ANTENNA BASE: ALUMINIUM ALLOY
  - OPERATING TEMPERATURE: -40°C ~ +85°C
  - STORAGE TEMPERATURE: -40°C ~ +85°C
  - CERTIFICATION: IP67, IP69, IK09

- CABLE 1: 5GNR
- CABLE 2: 5GNR
- CABLE 3: 2.4/5.0 GHz ISM
- CABLE 4: 2.4/5.0 GHz ISM
- CABLE 5: GPS/GLONASS

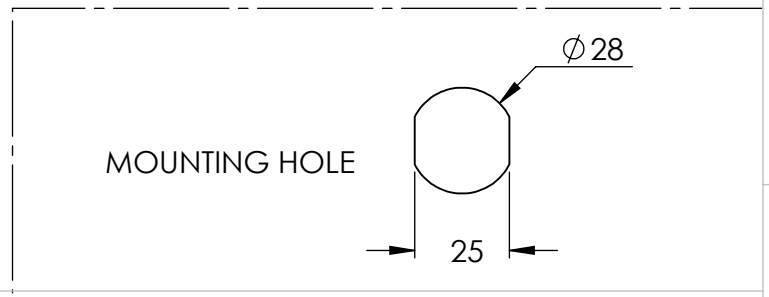

100-00240 CONFIGURATION TABLE				
DASH NO	CABLE TYPE	CABLE LENGTH	CONNECTOR TYPE	RADOME COLOR
-01	CABLE 1: LL195 CABLE 2: LL195 CABLE 3: LL195 CABLE 4: LL195 CABLE 5: LL100	200 CM 200 CM 200 CM 200 CM 200 CM	SMA-MALE SMA-MALE SMA-MALE-RP SMA-MALE-RP SMA-MALE	BLACK

ITEM 100-00240 REVISION HISTORY			
REV	DESCRIPTION	DATE	BY
A	INITIAL RELEASE	2022-01-28	JET

UNLESS OTHERWISE SPECIFIED:

DIMENSIONS ARE IN MM  
TOLERANCES:  
FRACTIONAL: ±  
ANGULAR: MACH ± .5° BEND ±  
ONE PLACE DECIMAL ± 1.0  
TWO PLACE DECIMAL ± .50

INTERPRET GEOMETRIC TOLERANCING PER:

THIRD ANGLE PROJECTION

DO NOT SCALE DRAWING

	NAME	DATE
DRAWN	JET	2022-01-28
CHECKED	ZX	2022-01-28
ENG APPR.	NPC	2022-01-28
MFG APPR.		
Q.A.		

CAD MAINTAINED. CHANGES SHALL BE INCORPORATED BY THE DESIGN ACTIVITY.

MAXTENA, INC

TITLE: 100-00240 MEA-5G-ISM-MIMO-GNSS

SIZE: B DWG. NO. 117-00576-01 REV: A

CAGE CODE: 5KQH7 SCALE: NONE SHEET 1 OF 1

PROPRIETARY AND CONFIDENTIAL  
THE INFORMATION CONTAINED IN THIS DRAWING IS THE SOLE PROPERTY OF MAXTENA, INC. ANY REPRODUCTION IN PART OR AS A WHOLE WITHOUT THE WRITTEN PERMISSION OF MAXTENA, INC IS PROHIBITED.

# Mouser Electronics

Authorized Distributor

Click to View Pricing, Inventory, Delivery & Lifecycle Information:

[Maxtena:](#)

[MEA-5G-ISM-MIMO-GNSS](#)