

M4HCT-A-SMA

L1: GPS, GLONASS, GALILEO, BEIDOU

Part #: 100-00117-01

Description

The M4HCT-A-SMA is an active multi-frequency, high-accuracy, GNSS antenna for the L1 GPS, Galileo, Beidou and GLONASS bands. The antenna is built on proprietary Maxtena Helicore® technology providing exceptional pattern control, polarization purity and high-efficiency in a compact form factor. It features an integrated SMA connector and rugged IP67 automotive grade components. The M4HCT-A-SMA is ideal for applications requiring minimal integration effort or for retrofitting existing products. The antenna is equipped with an O-ring.

Passive Antenna Performance

Parameter	Specification
Frequency	1559-1607 MHz (L1, E1, B1, B1-2, G1)
Peak Efficiency	49%
Polarization	RHCP
Realized Gain	0.5 dB
Axial Ratio	Max 0.9 dB at the Zenith
VSWR	Max 2:1
Beamwidth	125°

Phase Center Variation

Maximum Phase Center Variation (mm)	
In azimuth plane	Max 10 mm
As low as 40 degree elevation	Max 10 mm
Between samples	Max 5 mm
Over frequency band	Max 10 mm

RF Specifications

Parameter	Specification
Conducted Gain	30 dB ±3 dB
Noise Figure	1.5 dB typical, 2 dB max
Voltage	3.0 to 5.0 V
Current	25 mA max
Out of Band Rejection	40 dBc
Group Delay Variation	Less than 5ns over GNSS bands
EMI Immunity Out of Band	30 V/m
ESD Circuit Protection	15 kv human body model air discharge

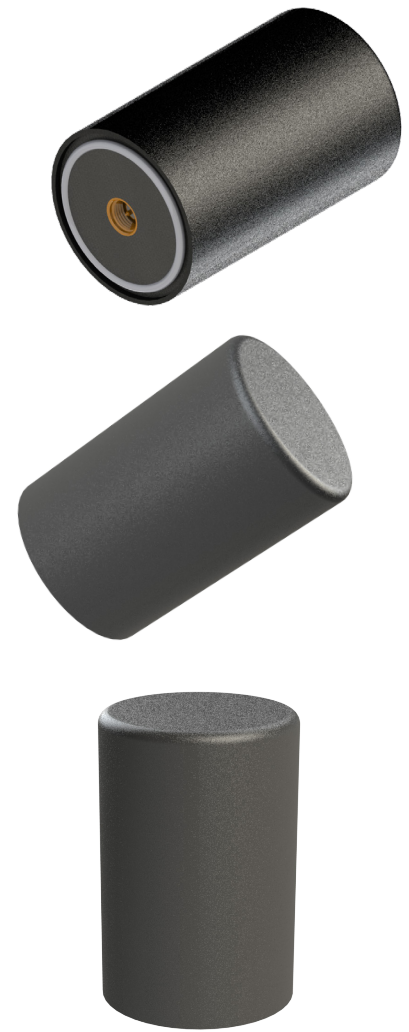

Antenna images not to scale

Features

- Quadrifilar helix antenna
- Concurrent GNSS reception on L1: GPS, GLONASS, Galileo, Beidou
- Rugged IP67 rating with SMA mount
- Small form factor
- Ground plane independent
- GIS, RTK and other high accuracy GNSS applications
- Low power consumption
- Low phase center variation over azimuth and elevation and among different samples
- Ultra-lightweight
- Automotive grade electronics

L1 band radiation patterns

Maxtena's M4HCT-A-SMA uses patented Helicore® technology which results in minimal dependence on frequency and features a wide beamwidth, low axial ratio and radiation pattern symmetry across all desired frequencies in the L1 band.

RHCP Realized Gain [dBic] - Elevation Cuts

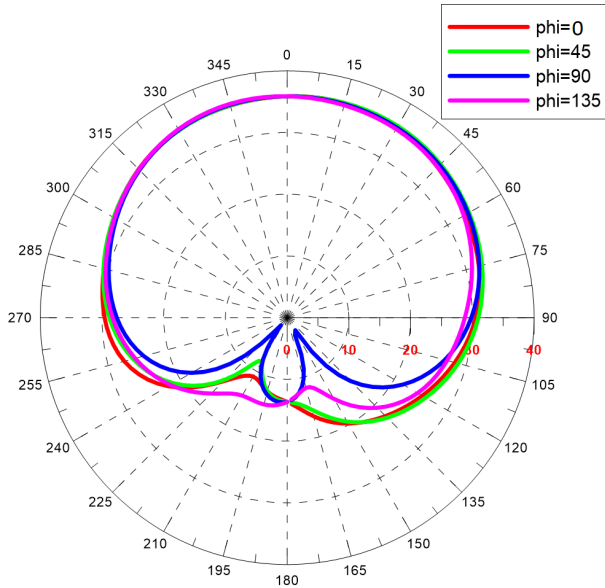

A 125 degree beamwidth ensures excellent hemispherical coverage.

RHCP Realized Gain [dBic] - Azimuth Cuts

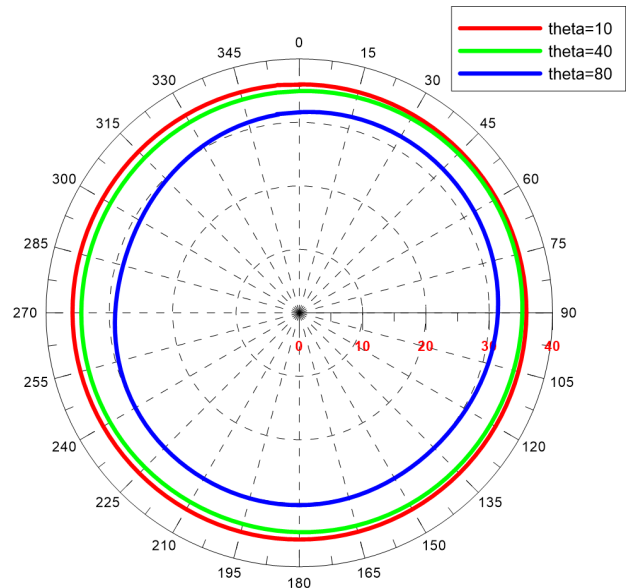

Symmetric coverage even in low elevation enhances accuracy.

Axial Ratio [dB] - Zenith

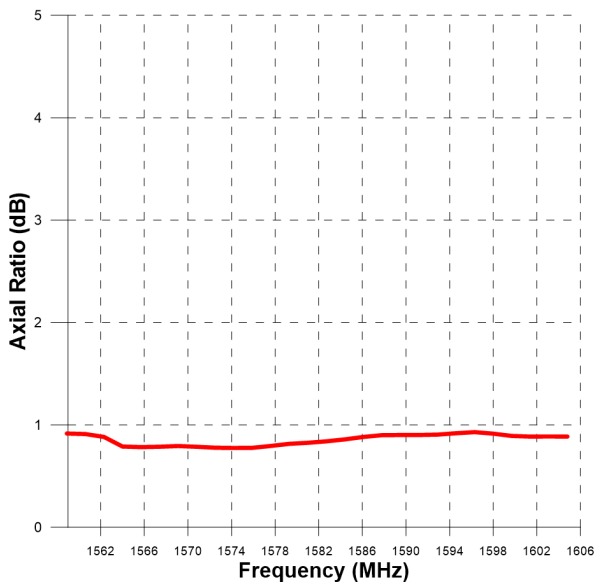

Axial Ratio [dB] - Azimuth Cuts

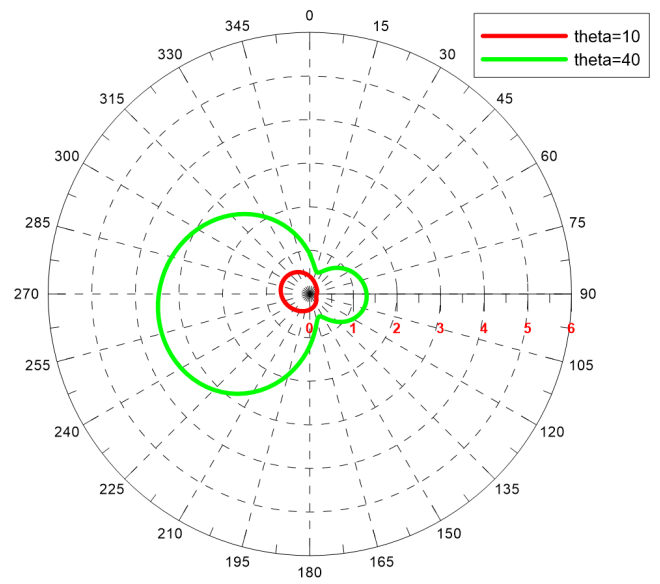

Phase Center Variation

Maxtena's M4HCT-A-SMA has minimal phase center variation over azimuth and elevation in the L1 band.

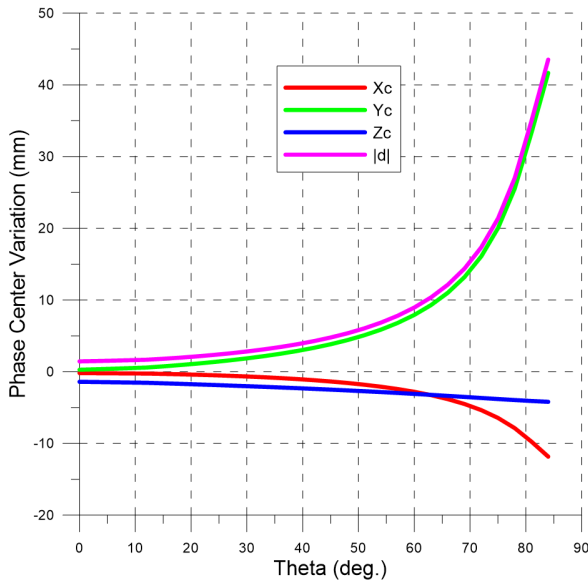

Phase Center Variation vs. Elevation in L1 band.

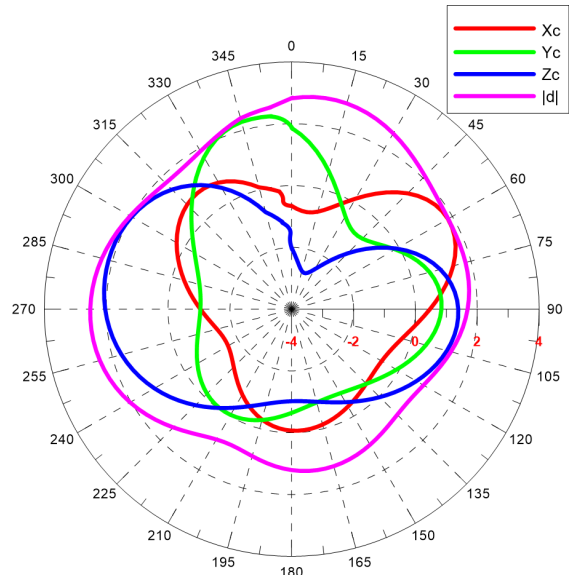

Phase Center Variation vs. Azimuth at Theta=30° in L1 band.

Excellent Group Delay Variation

Using GPS signal carrier phase to increase accuracy in GNSS applications has been proven reliable and has made mm-level accuracy possible. However, in resolving carrier phase ambiguity, it is necessary to make sure carrier phase is received and measured accurately and that the effect of antenna and receiver on carrier phase is minimized. Maxtena's M4HCT-A-SMA has a flat response over the GNSS band that it covers and has minimal group delay variation over frequency.

Filtering and LNA Performance

Maxtena's M4HCT-A-SMA antenna has a flat response over the L1 GNSS bands, with less than 1 dB variation over the band. The superior out-of-band rejection ensures minimal interference.

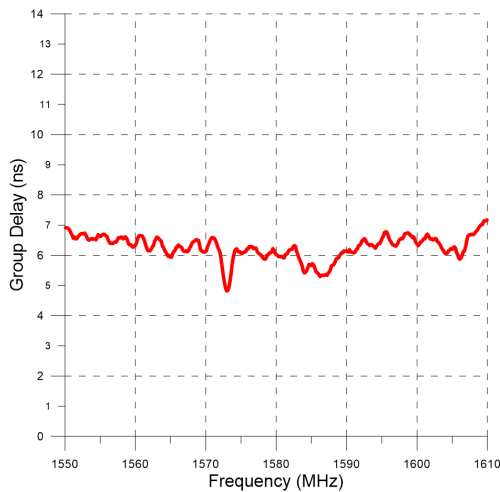

< 2 ns group delay variation over L1-band.

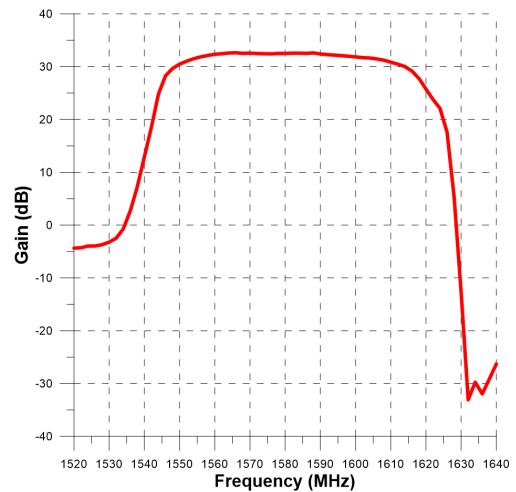

Flat conducted gain response.

Mechanical Specifications

Parameter	Specification
Operating Temperature Range	-40 to +105°C
Environmental Standards	IP67 rating
Cabling and Connector	No cable, male SMA connector
Weight	25 grams

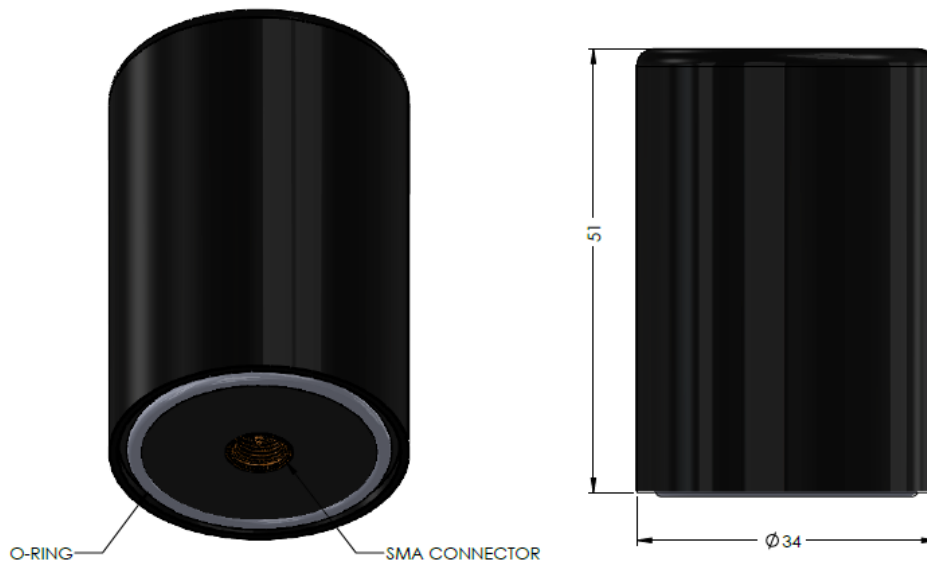

Dimensions are in mm.