



# MEA-5900-CM

## 2.4/5.0/6.0 GHz ISM Connector Mount

Part #: 100-00300-01

### Description

The MEA-5900-CM connector Mount Antenna is a low profile antenna solution, with a very high-performance ideal for maintaining constant network connectivity. The MEA-5900-CM covers all 2.4/5.0/6.0 ISM standard frequencies. This is an ideal antenna for telematics systems, remote surveillance, asset tracking and any IOT WIFI system applications. The high performance and low profile make this antenna ideal for the most challenging installations.

This connector mount antenna is easy to install with maximum durability housing and anti-rotation mounting. The MEA-5900-CM has a hinged Connector and SMA Connector.

### Electrical Specification

Parameter	Specifications	
Standards	WiFi, BT, ZigBee, ISM	
Band	2.4 GHz	5.0 GHz
Frequency Range	2410-2490 MHz	4920-5925 MHz
Return Loss	~-17.1	~-12.3
VSWR	~1.4:1	~1.7:1
Efficiency (%)	~75.8	~84.5
Peak Gain (dBi)	~4.1	~3.9
Average Gain (dB)	~-1.2	~-0.7
Impedance (Ohm)	50	
Polarization	Linear	
Radiation Pattern	Omni-Directional	
Max Input Power	25	
Connector Type	Most RF Connectors (RP-SMA-Male Standard)	

### Mechanical Specification

Parameter	Specifications
Antenna Dimensions (mm)	135 x 19 x 10
Operating Temperature (C)	-40 to +85
Storage Temperature (C)	-40 to +85
Mounting Type	Connector Mount
Radome/Color	ABS UV Stable/ Black
Substance Compliance	RoHS
Measured in	Certified CTIA 3D Anechoic Chamber
Connector Feature	Hinged

\*Mounted on Free Space



### Features

- 2.4/5.0/6.0 GHz ISM - 2410-2490 MHz - 4920-7125 MHz frequency coverage
- WiFi 6E Antenna
- High Gain
- Ground Plane Independent
- Hinged Connector
- Dimensions 135 x 19 x 10 mm

### Applications

- WiFi applications
- Navigation and telematics systems
- IoT
- Automotive connectivity
- Multimedia
- Fleet management
- HD video and audio streaming



Maxtena Inc.  
7361 Calhoun Place, Suite 102  
Rockville, MD 20855  
1-877-629-8362  
info@maxtena.com

[www.maxtena.com](http://www.maxtena.com)

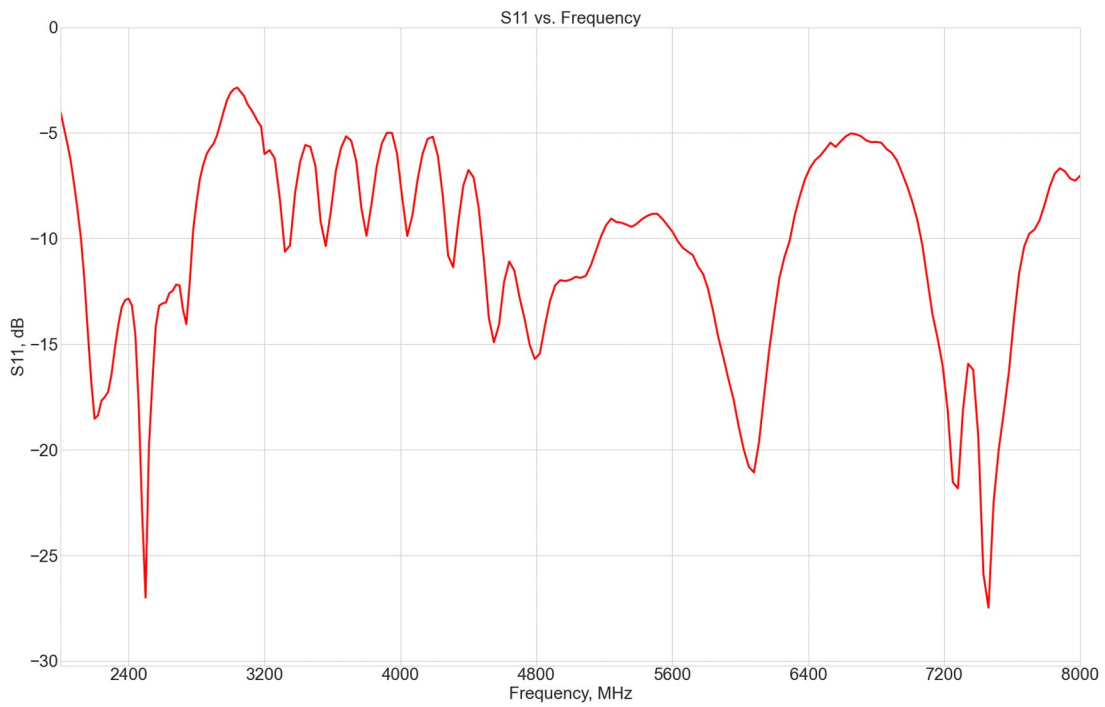
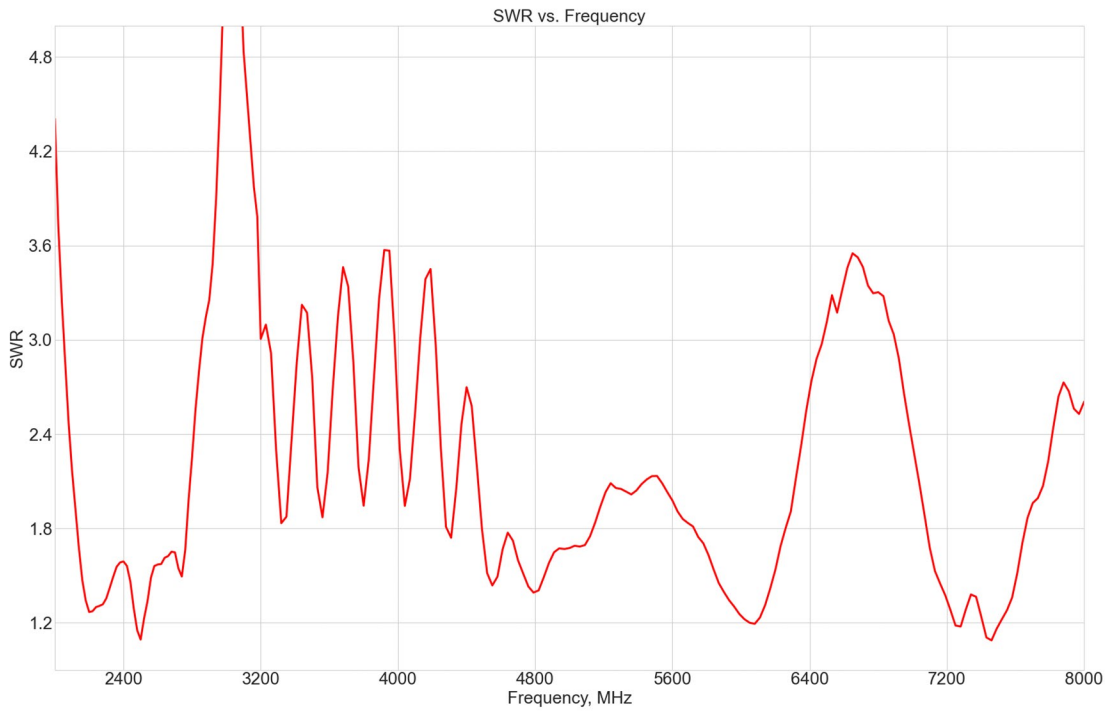

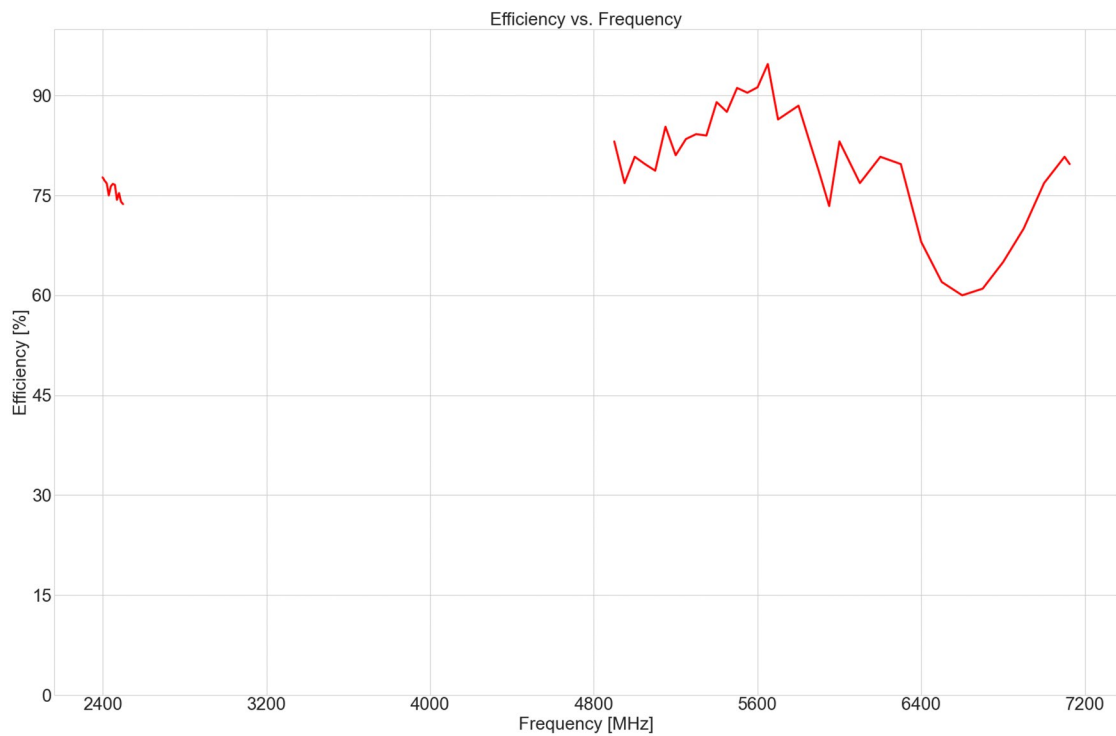
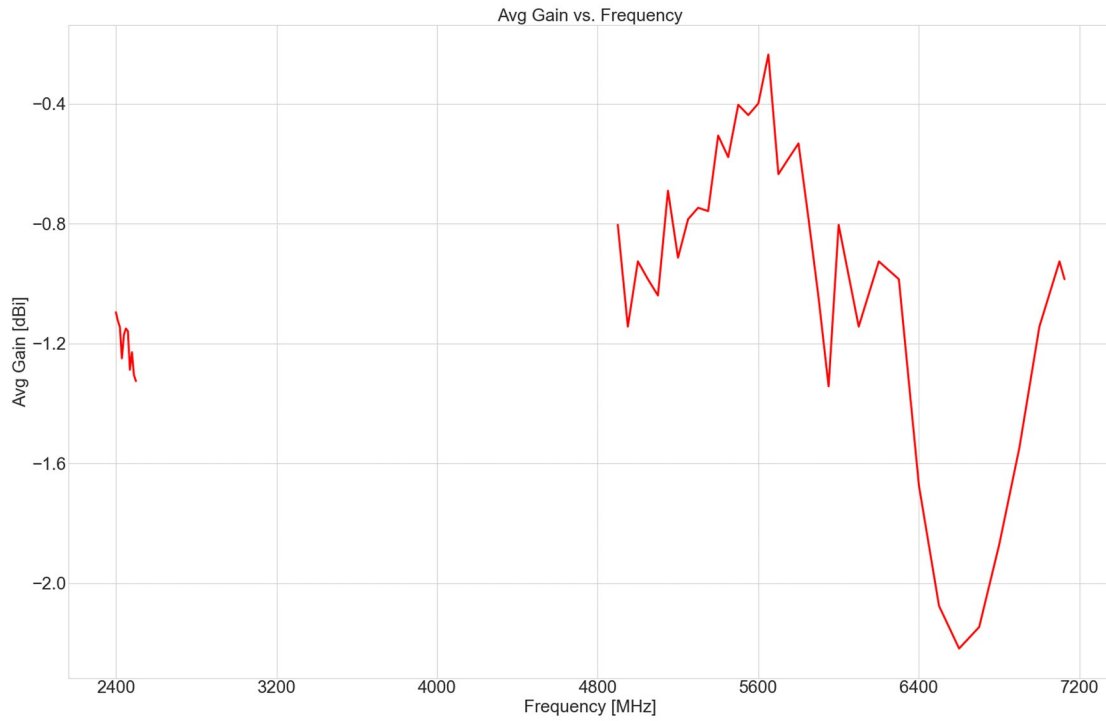

Maxtena Inc.  
 7361 Calhoun Place, Suite 102  
 Rockville, MD 20855  
 1-877-629-8362  
 info@maxtena.com  
 www.maxtena.com

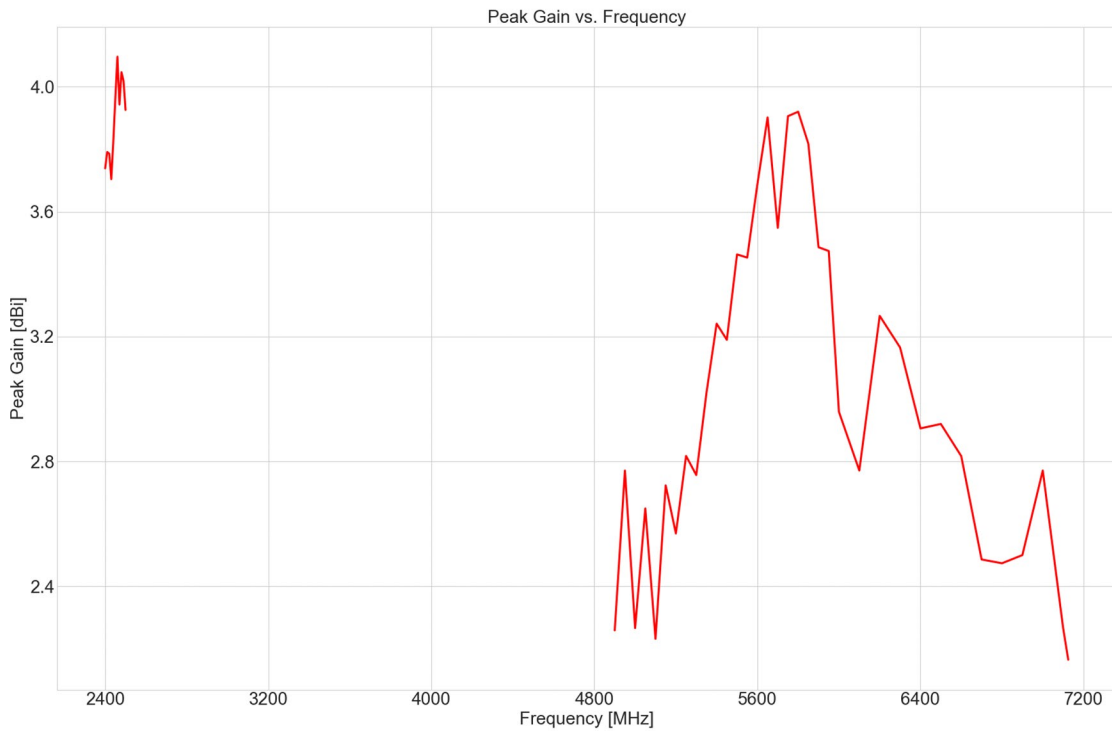

Maxtena Inc.  
7361 Calhoun Place, Suite 102  
Rockville, MD 20855  
1-877-629-8362  
info@maxtena.com  
[www.maxtena.com](http://www.maxtena.com)

DRAWING REVISION HISTORY			
REV	DESCRIPTION	DATE	BY
A	INITIAL RELEASE	2022-08-21	MP

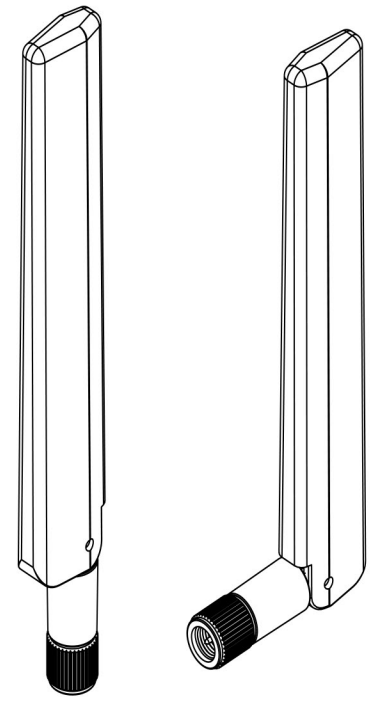
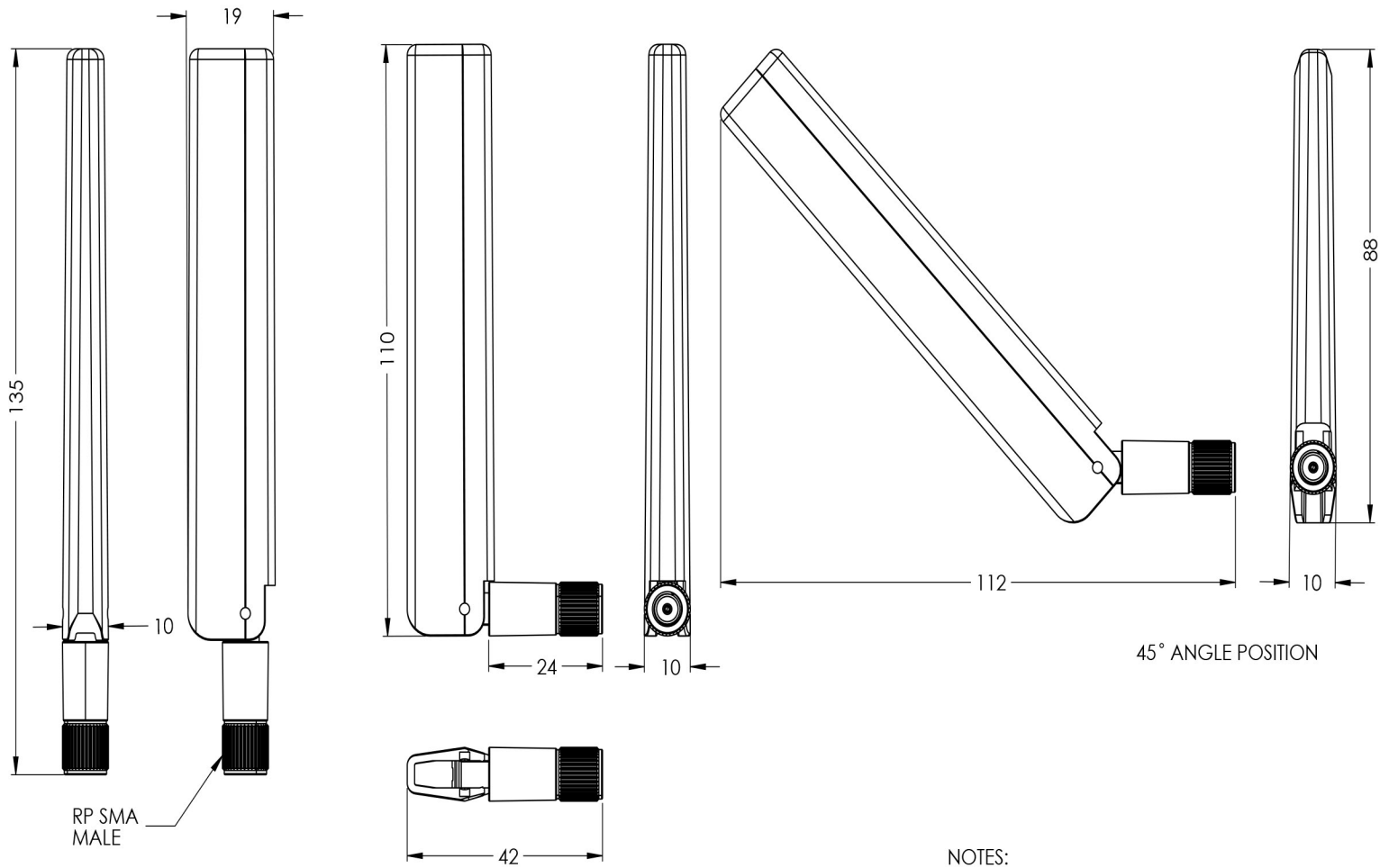

- NOTES:
1. FREQUENCY: 2410MHz-2490MHz, 4920MHz-5925MHz
  2. MOUNTING TYPE: CONNECTOR MOUNT
  3. DIMENSIONS ARE AFTER MOUNTING
  4. MATERIALS:
    - RADOME: ABS UV STABLE
    - RADOME COLOR: BLACK
  5. OPERATING TEMPERATURE: -40°C ~ +85°C
  6. STORAGE TEMPERATURE: -40°C ~ +85°C

ITEM 100-00300 REVISION HISTORY			
REV	DESCRIPTION	DATE	BY
A	INITIAL RELEASE	2022-08-21	MP

100-00300 CONFIGURATION TABLE		
DASH NO	CONNECTOR TYPE	RADOM COLOR
-01	RP SMA MALE	BLACK

UNLESS OTHERWISE SPECIFIED:	NAME	DATE
DIMENSIONS ARE IN MM	DRAWN	MP 2022-08-21
TOLERANCES:	CHECKED	ZX 2022-08-31
FRACTIONAL ±	ENG APPR.	NPC 2022-09-08
ANGULAR: MACH ± .5° BEND ±	MFG APPR.	
ONE PLACE DECIMAL ± 1.0	Q.A.	
TWO PLACE DECIMAL ± .50		
INTERPRET GEOMETRIC TOLERANCING PER:	CAD MAINTAINED. CHANGES SHALL BE INCORPORATED BY THE DESIGN ACTIVITY.	
	DO NOT SCALE DRAWING	

MAXTENA, INC		
TITLE: 100-00300 MEA-5900-CM		
SIZE	DWG. NO.	REV
B	117-00667-01	A
CAGE CODE: 5KQH7	SCALE: NONE	SHEET 1 OF 1

PROPRIETARY AND CONFIDENTIAL  
THE INFORMATION CONTAINED IN THIS DRAWING IS THE SOLE PROPERTY OF MAXTENA, INC. ANY REPRODUCTION IN PART OR AS A WHOLE WITHOUT THE WRITTEN PERMISSION OF MAXTENA, INC IS PROHIBITED.