



M10HCT-A-EMB

L1-L2-L5 GNSS ACTIVE ANTENNA

Part #: 180-00090-02

Description

M10HCT-A-EMB is a L1-L2-L5 active antenna solution intended to cover all GPS, Galileo, Glonass, BeiDou bands including L-Band correction services coverage. Low profile RHCP, wide band antenna is ideal solution for high-precision applications, such as autonomous vehicle navigation, smart survey devices, and maritime positioning. This antenna is built on proprietary Maxtena Helicore® technology. This technology provides exceptional pattern control, polarization purity and high efficiency in a very compact form factor. Low axial ratio ensures that the antenna captures RHCP signal well and mitigates the reflected LHCP signals. Antenna ensures high signal-to-noise ratio (SNR) and GNSS signal tracking from all elevation angles in all types of environments. The embedded version is custom tuned to the application's enclosure.

Active Circuit Performance

Parameter	Specification
Conducted gain	34.5 dB @ upper band 35.4 dB @ lower band
Noise figure	3.1 dB @ upper band 2.9 dB @ upper band
Voltage	2.3 V - 16 V
Current	40 mA (max.)
Out of band rejection	≥ 70 dB @ ≥ 1700 MHz ≥ 35 dB @ ≥ 1650 MHz ≥ 35 dB @ 1450 - 1520 MHz ≥ 60 dB @ 1350 - 1450 MHz ≥ 80 dB @ ≤ 1125 MHz
Group delay variation	< 3 ns @ L1 < 4 ns @ L2 < 22 ns @ L5
EMI Immunity Out of Band	30 kV
Output P1dB	12.5 dBm @ upper band 13.1 dBm @ lower band

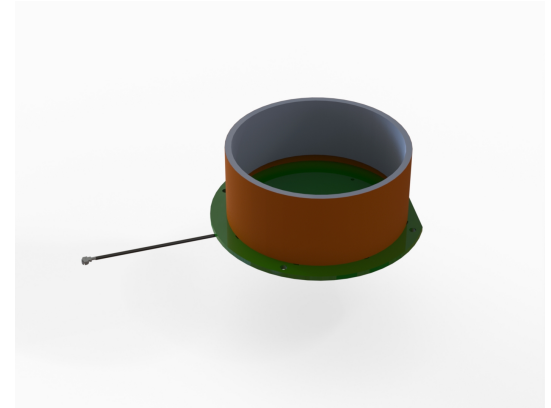

Features

- Full GPS, Galileo, Glonass, BeiDou bands coverage including L-Band correction services coverage
- Low Axial Ratio
- Low Noise Figure
- Ground plane independent
- Low power consumption
- Low phase center variation over azimuth and elevation and among different samples
- RoHs compliant
- Automotive grade electronics

Applications

- UAV/Drones
- Unmanned Ground Vehicles (UGV)
- Unmanned Systems
- High Precision Navigation
- Military & Security
- Agriculture & FarmTech
- Marine systems

Passive antenna performance

Parameter	Specification
Frequency Range	1164 - 1300 MHz 1539 - 1610 MHz
Peak gain	3.4 dBic @ upper band 3.3 dBic @ lower band
Peak efficiency	80 % @ upper band 75 % @ lower band
Axial Ratio	0.5 dB (max.) @ zenith
Polarization	RHCP
Beamwidth	120°

Mechanical specification

Parameter	Specification
Antenna Dimensions	Ø71 x 31 mm
Weight	32 g
Operating Temperature	-40 °C to 85 °C
Mounting Type	Screw Mount
Connector	U.FL

Antenna Characteristics

Return Loss

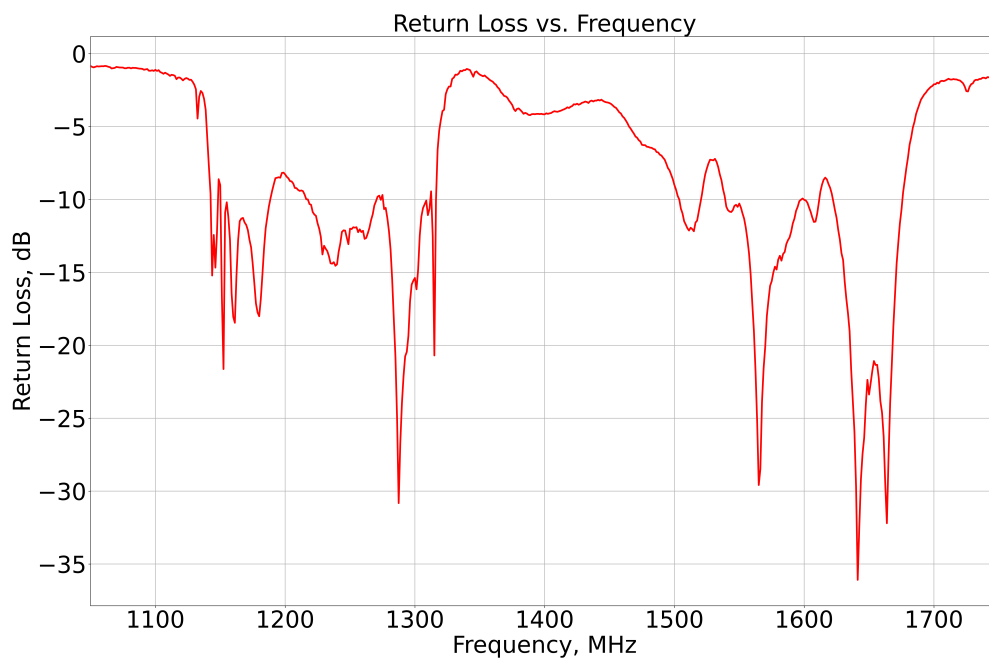

VSWR

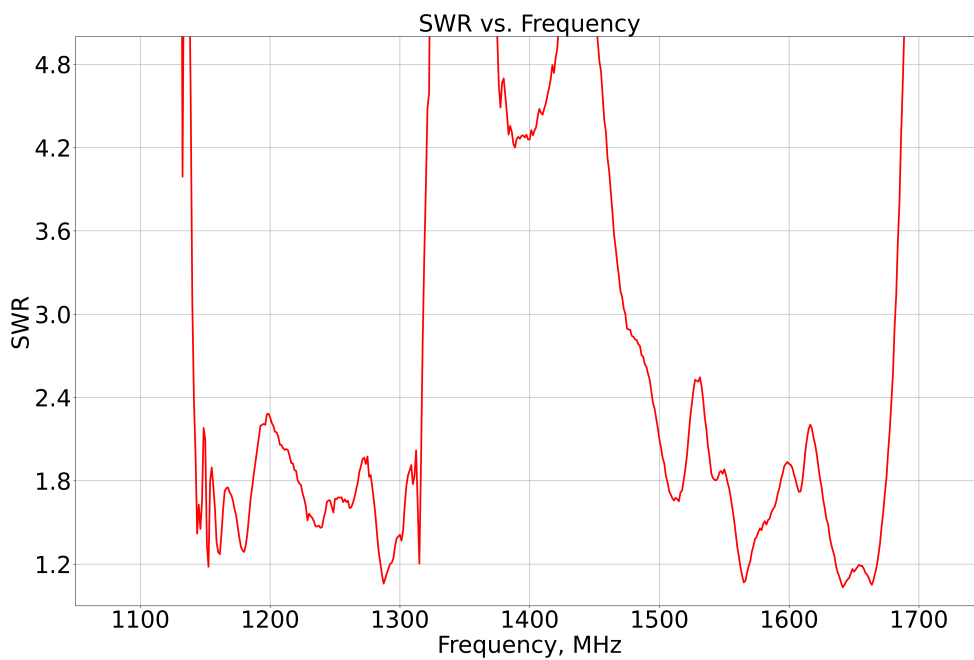

Efficiency

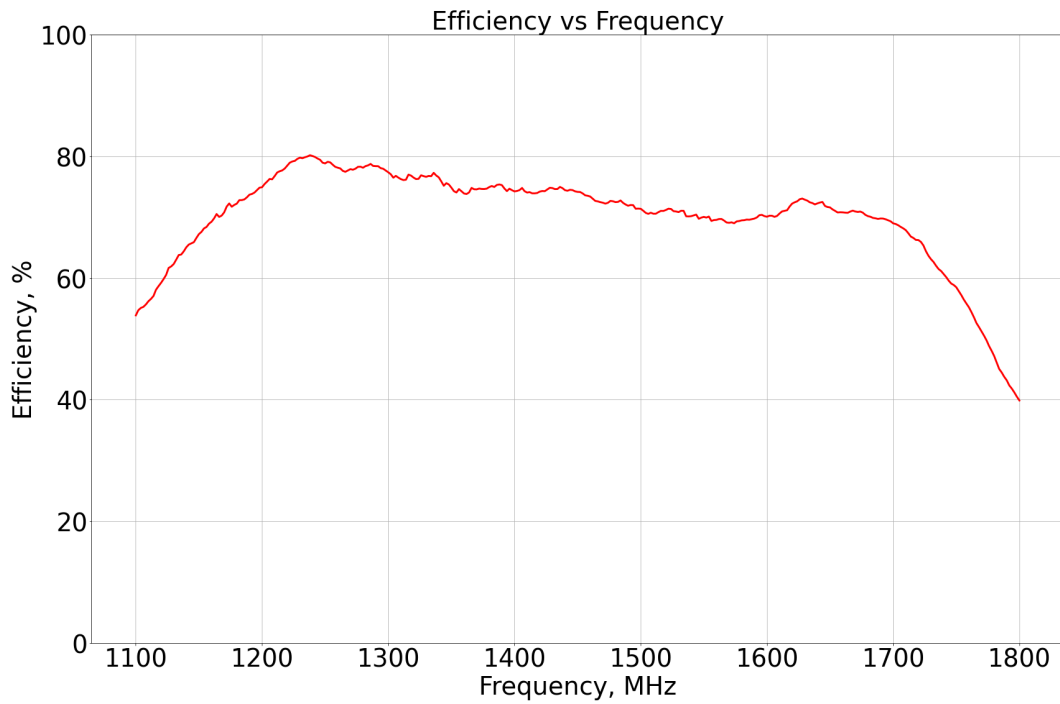

Gain

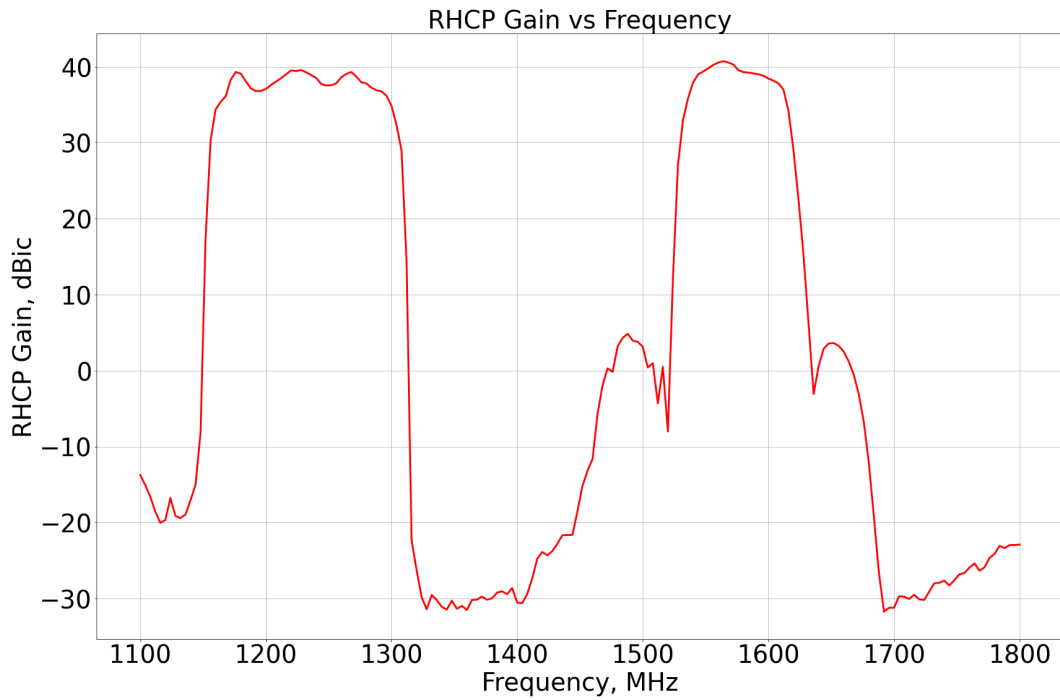

2D Radiation Patterns

Maxtena's M10HCT-A-EMB has unique features that make it the best option for high-accuracy GNSS applications. Full hemispherical coverage is achieved by an exceptionally large 3 dB beamwidth, ensuring full view of sky and satellites in lower elevation angles. Highly symmetric radiation pattern guarantees there will be no direction of weak reception or blind spots.

L1 band

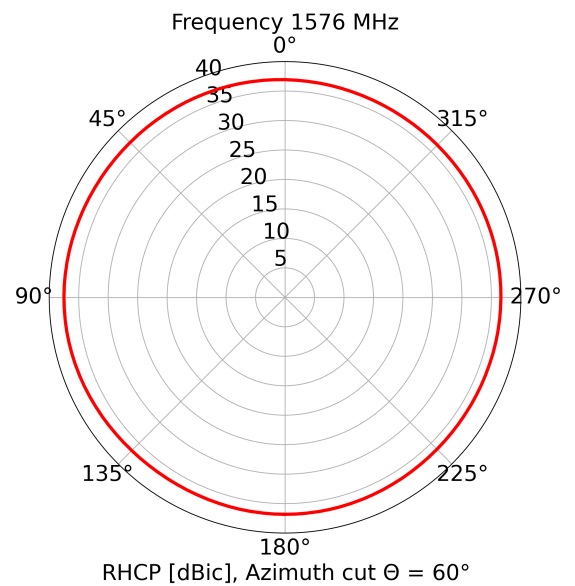
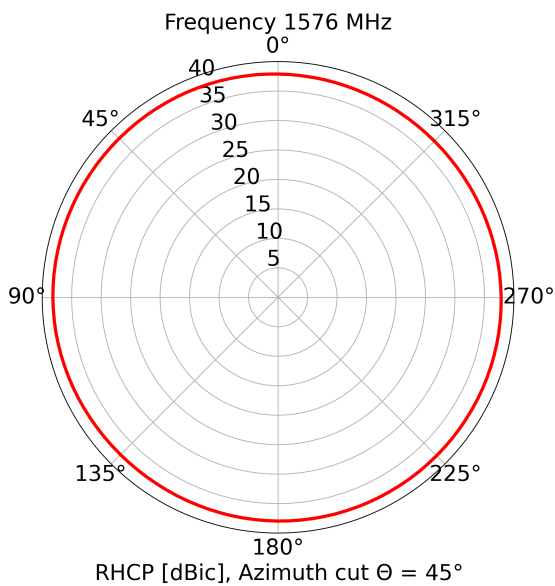
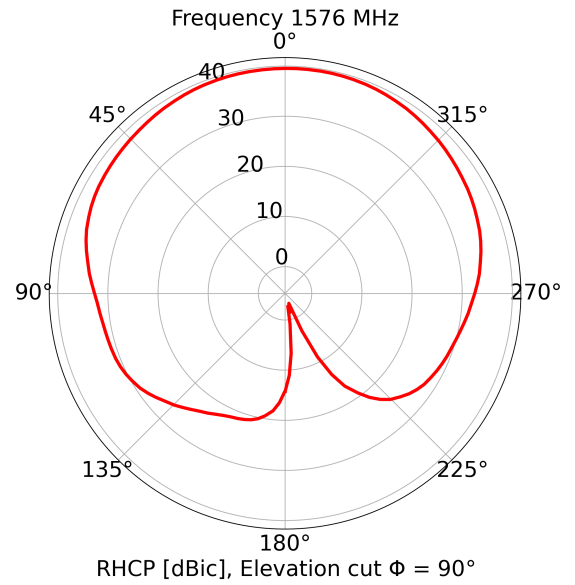
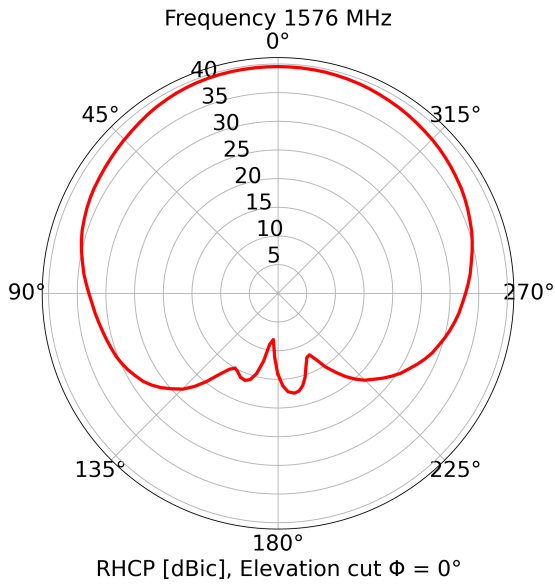

L2 band

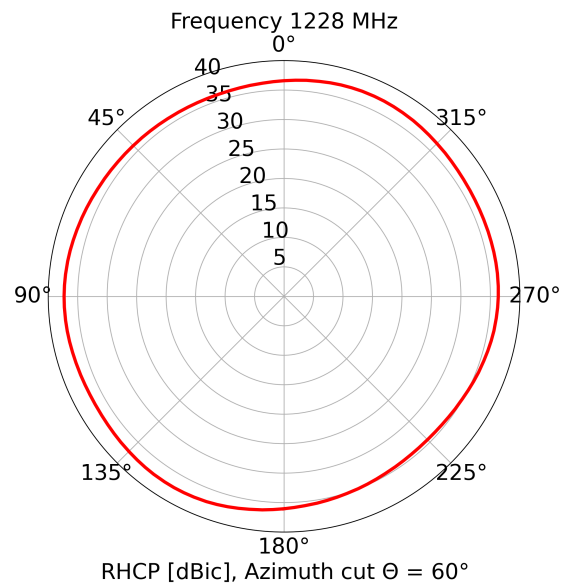
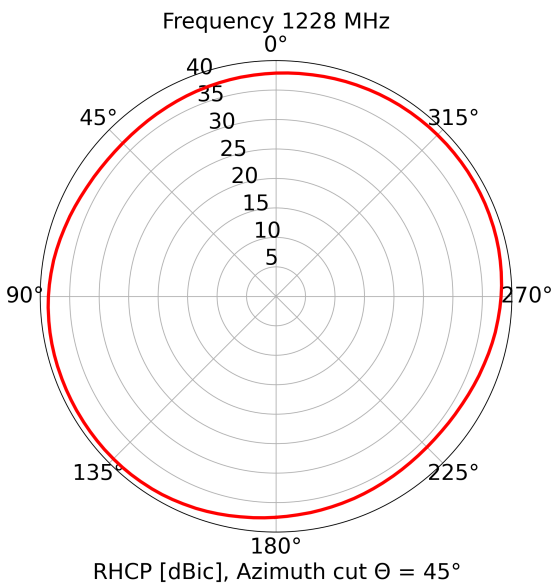
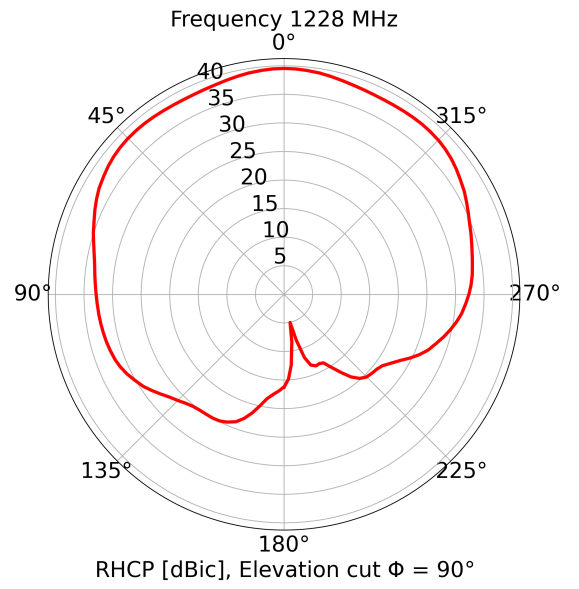
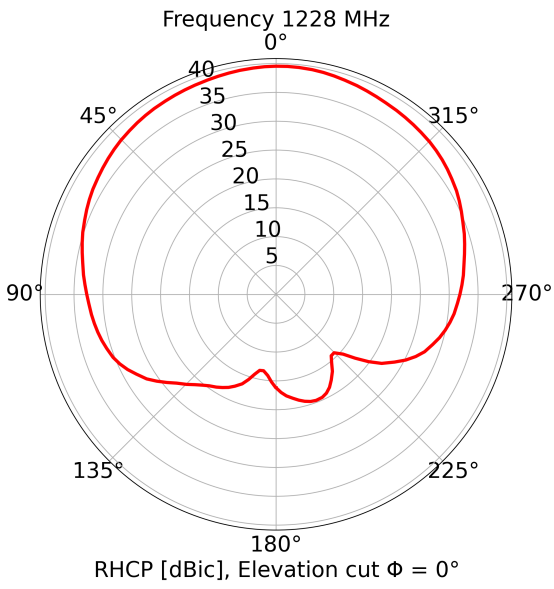

L5 band

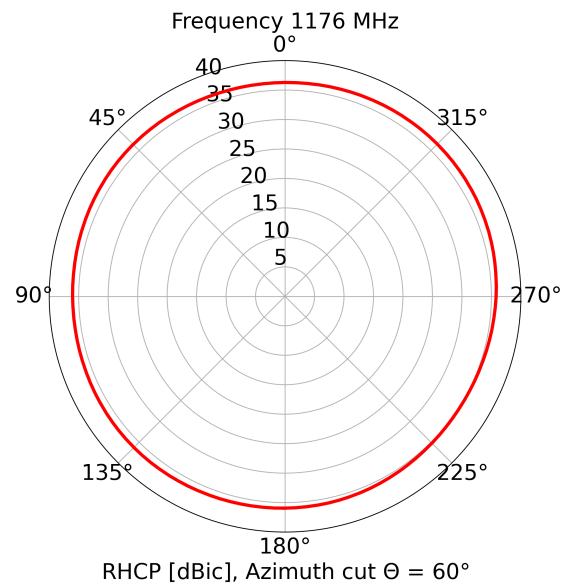
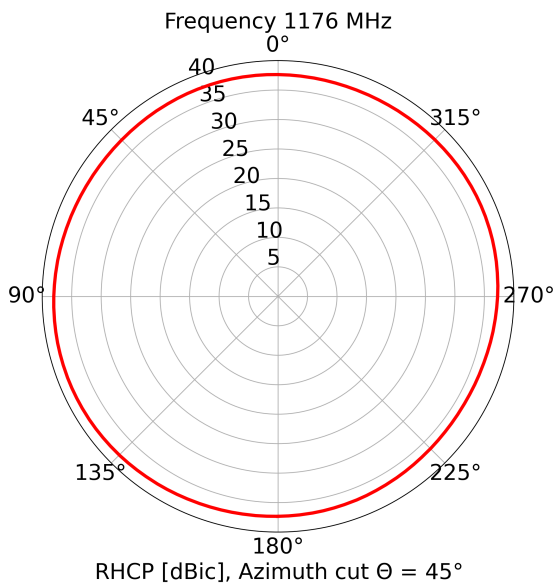
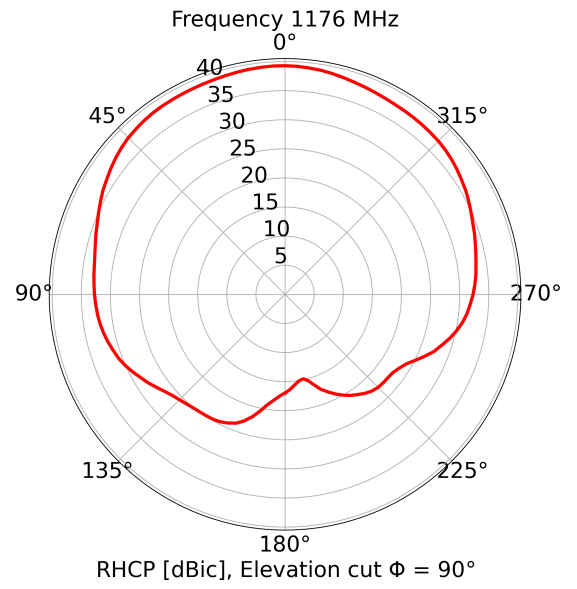
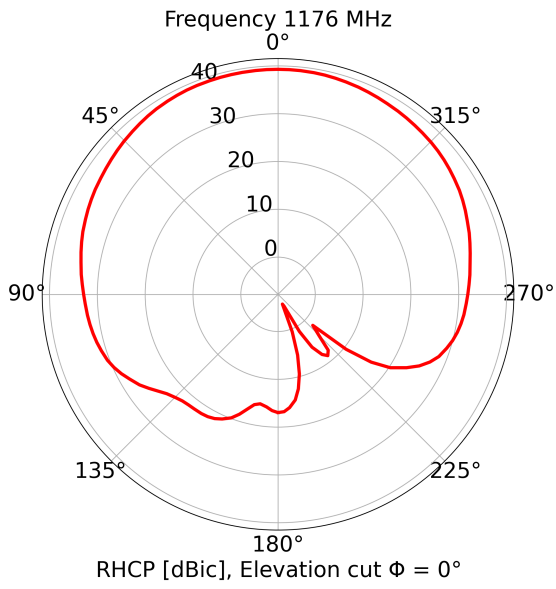

3D Radiation Patterns

L1 band

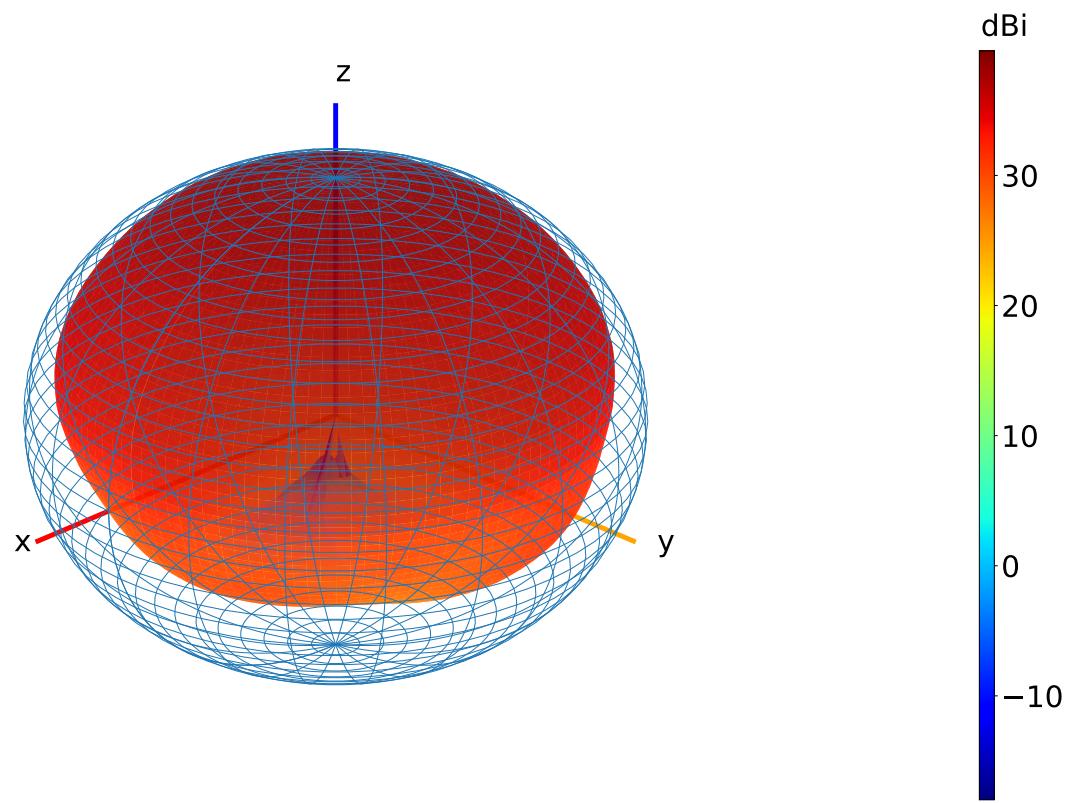

L2 band

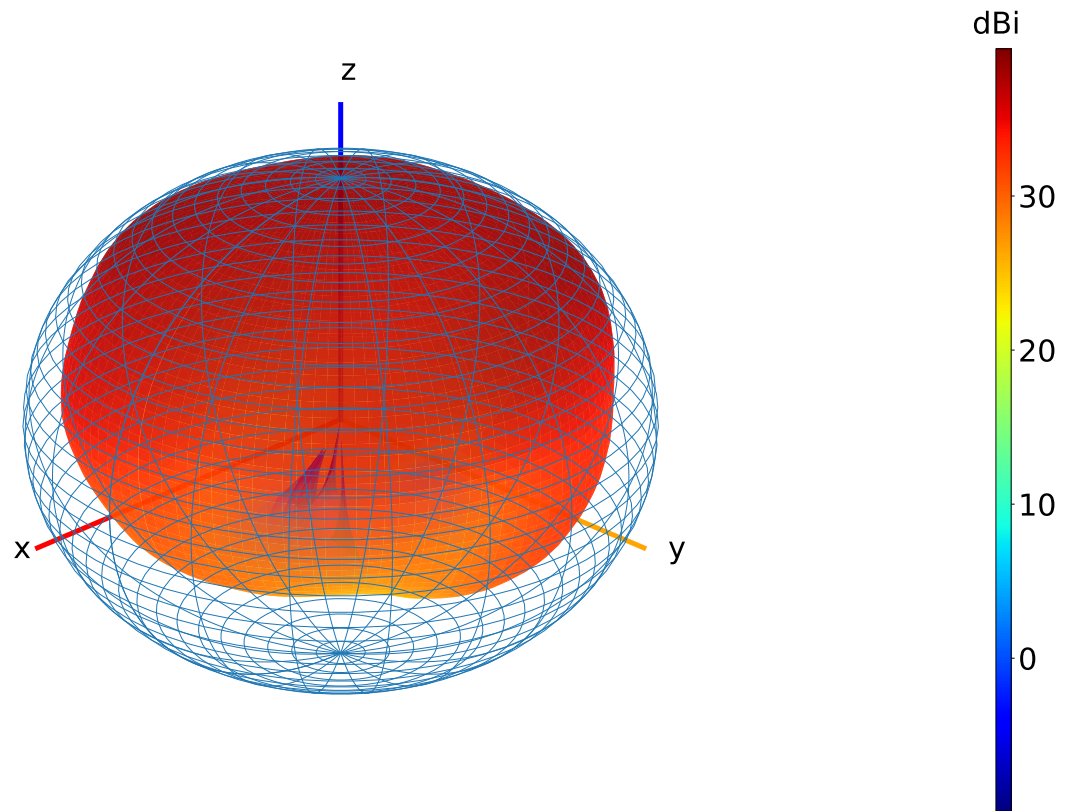

L5 band

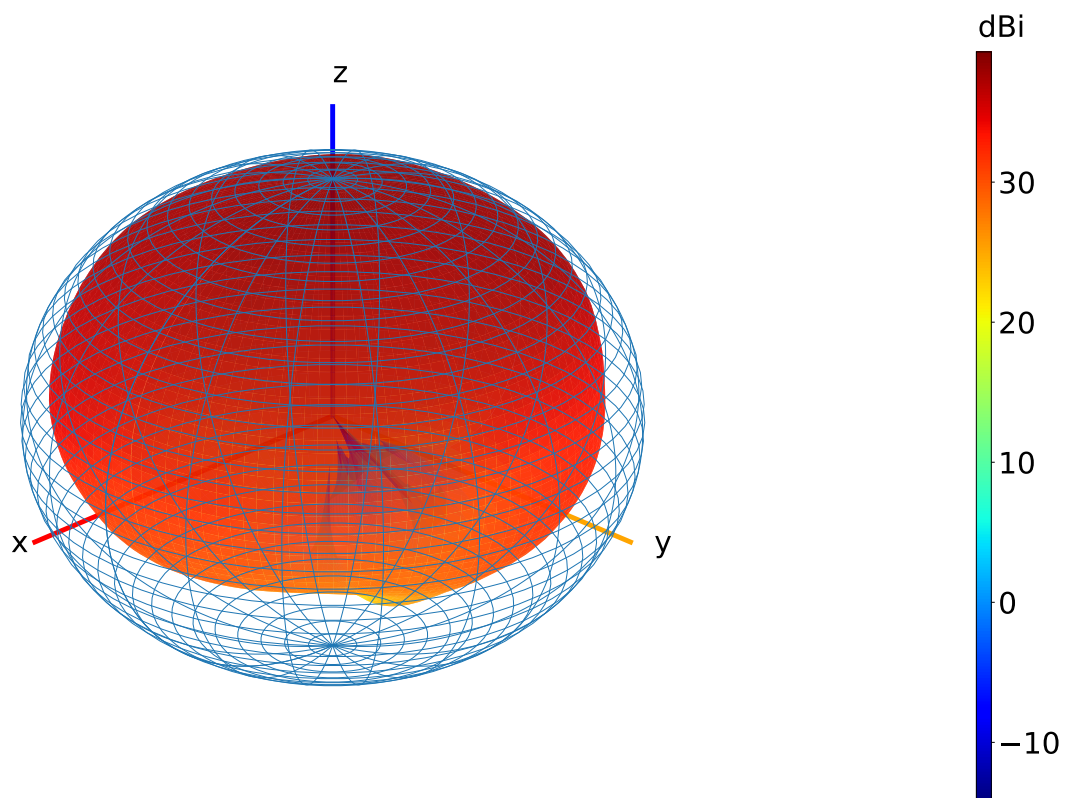

Axial Ratio

Axial Ratio is a very important parameter for high-accuracy GNSS applications. Ideally GNSS signals travel directly from the GNSS satellite to the receiver antenna. But buildings, trees, water, and road surfaces can cause GNSS signals reflection. Reflected signals change from right hand circular polarization to left hand circular polarization. A low axial ratio at the zenith and other elevation angles ensures multipath error is mitigated.

L1 band

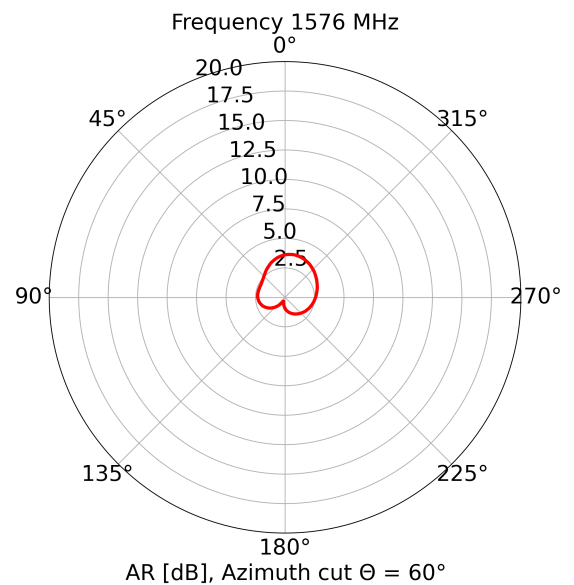
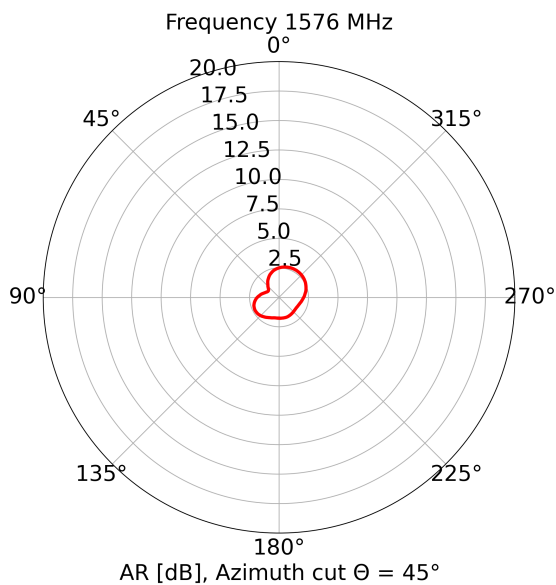
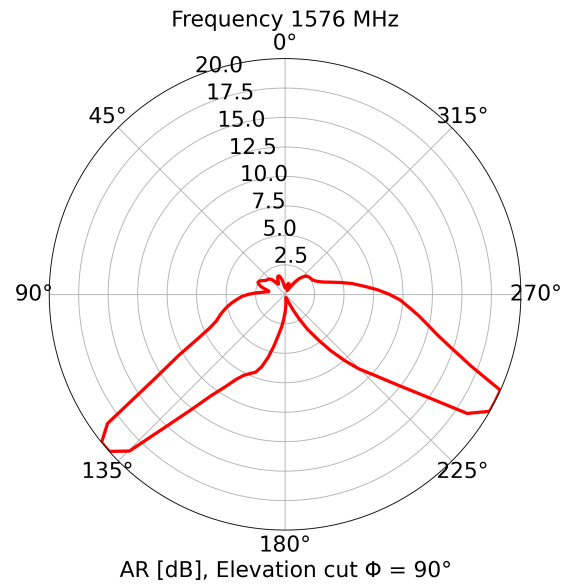
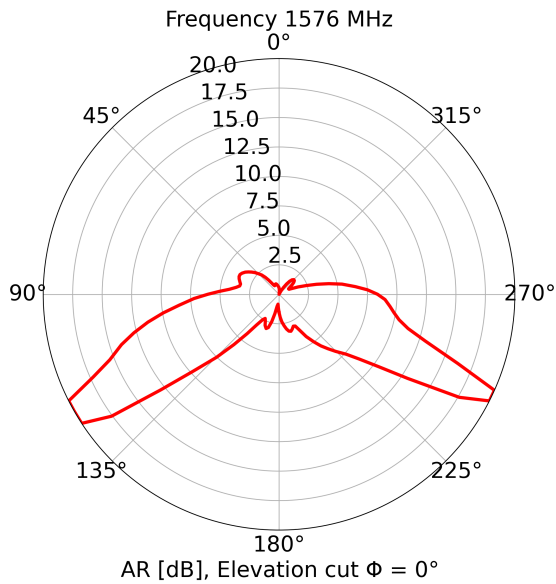

L2 band

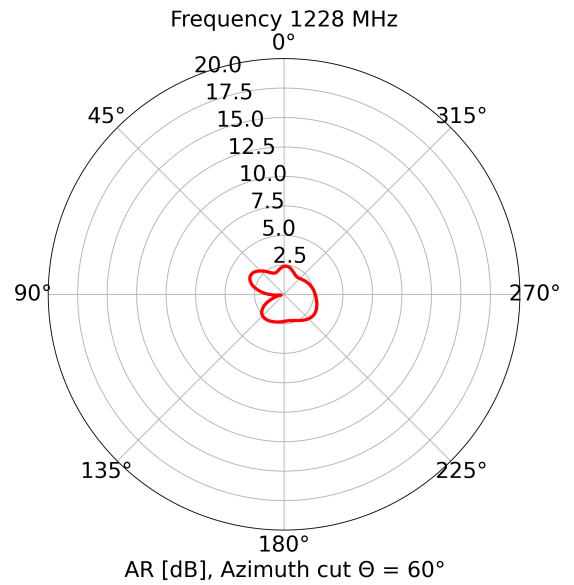
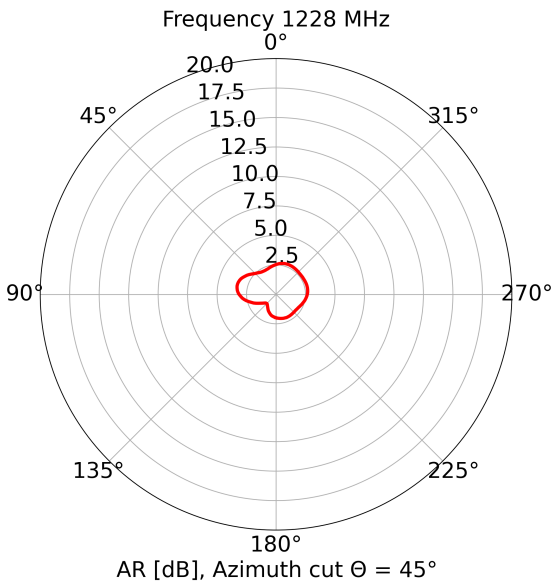
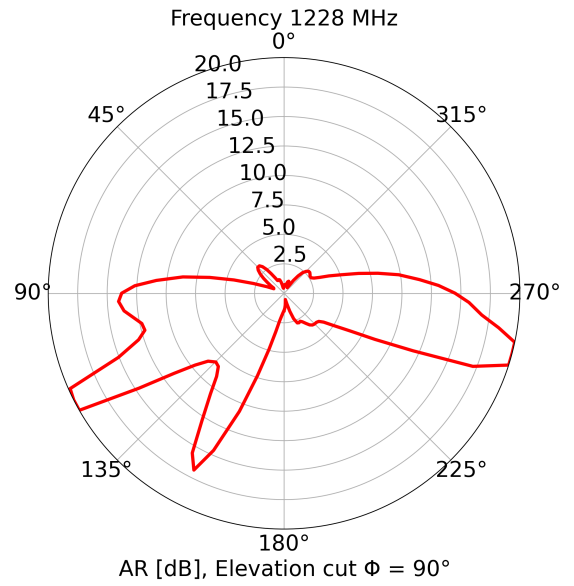
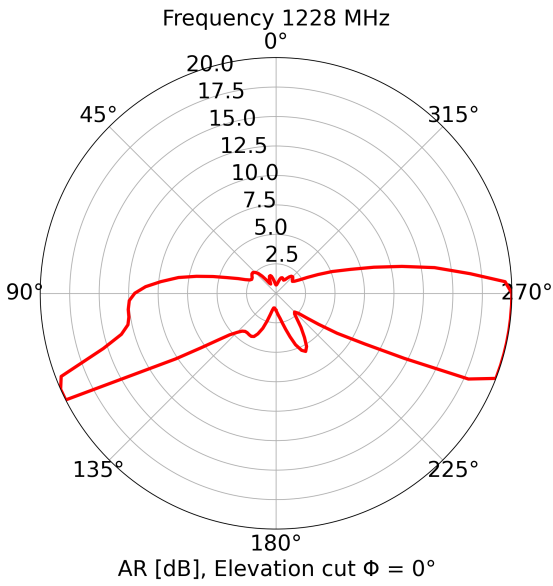

L5 band

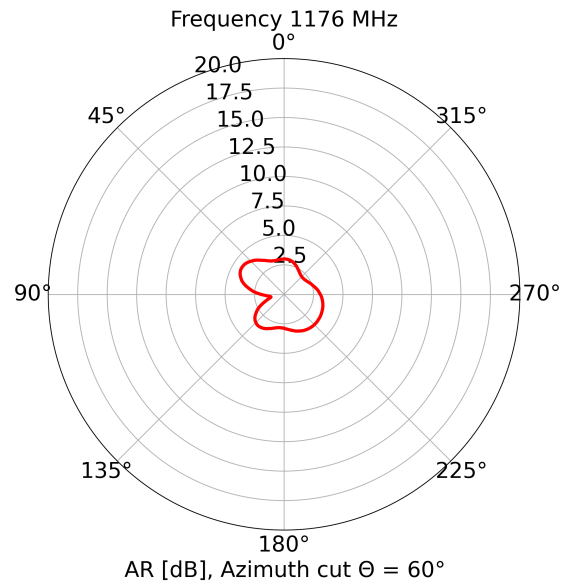
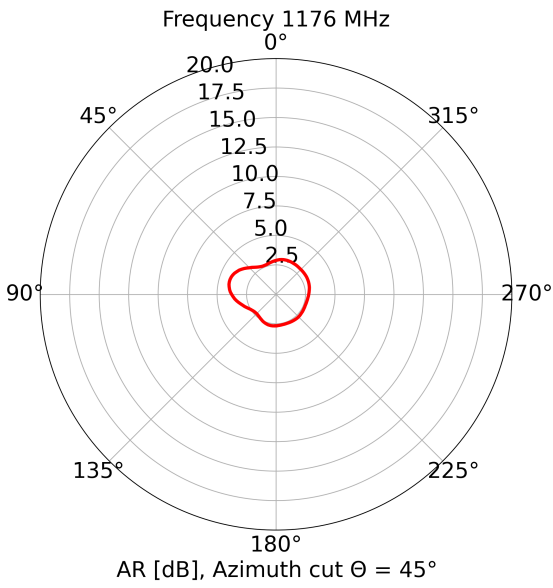
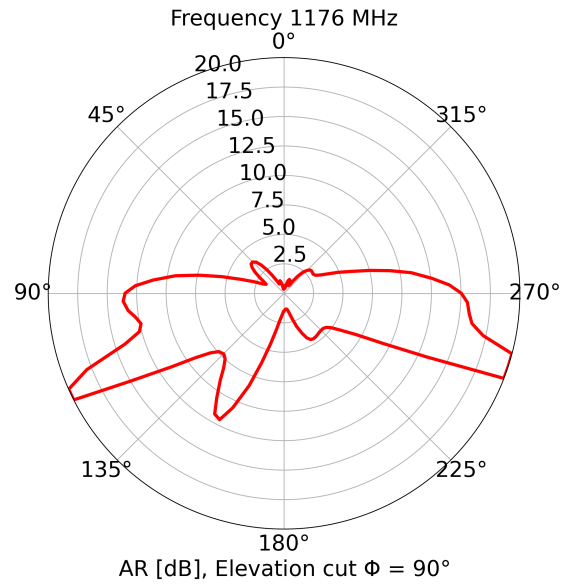
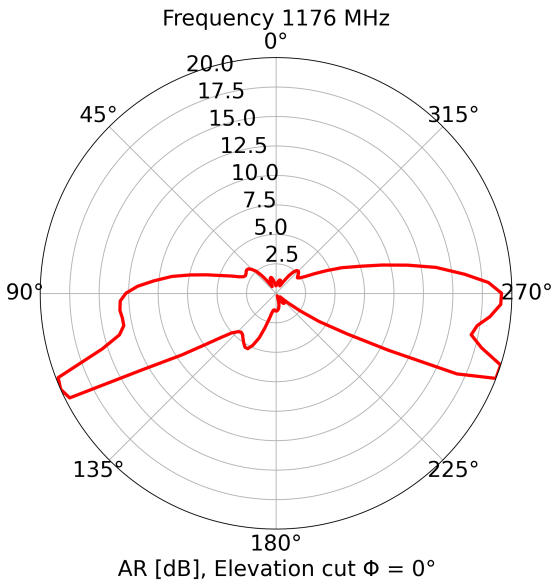

Phase center offset

Phase center offset and phase center variation values are important parameter in GPS precise positioning. Maxtena's M10HCT-A-EMB has minimal phase center variation over azimuth and elevation in all GNSS bands.

PCO	L1 band	L2 band	L5 band
x-axis	21.9 mm	20.2 mm	20 mm
y-axis	1.4 mm	-0.7 mm	0.8 mm
z-axis	14.2 mm	17.1 mm	17.5 mm

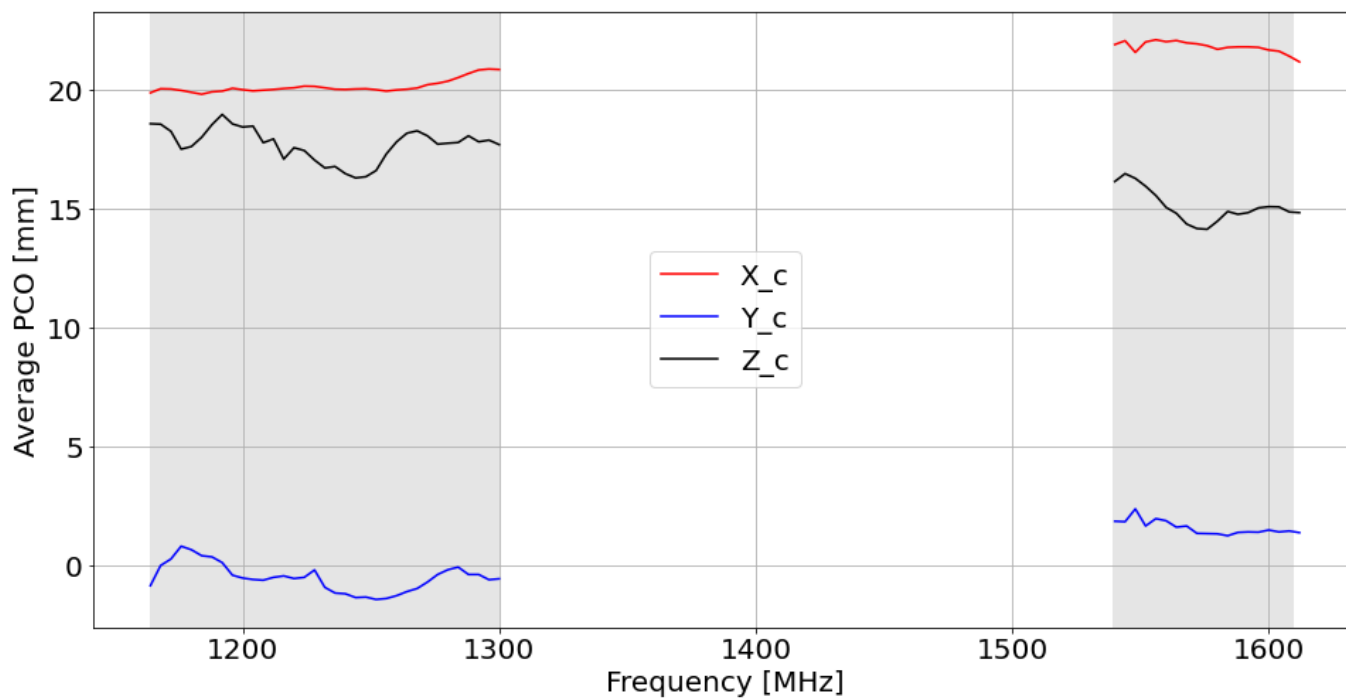

Phase center variation

L1 band

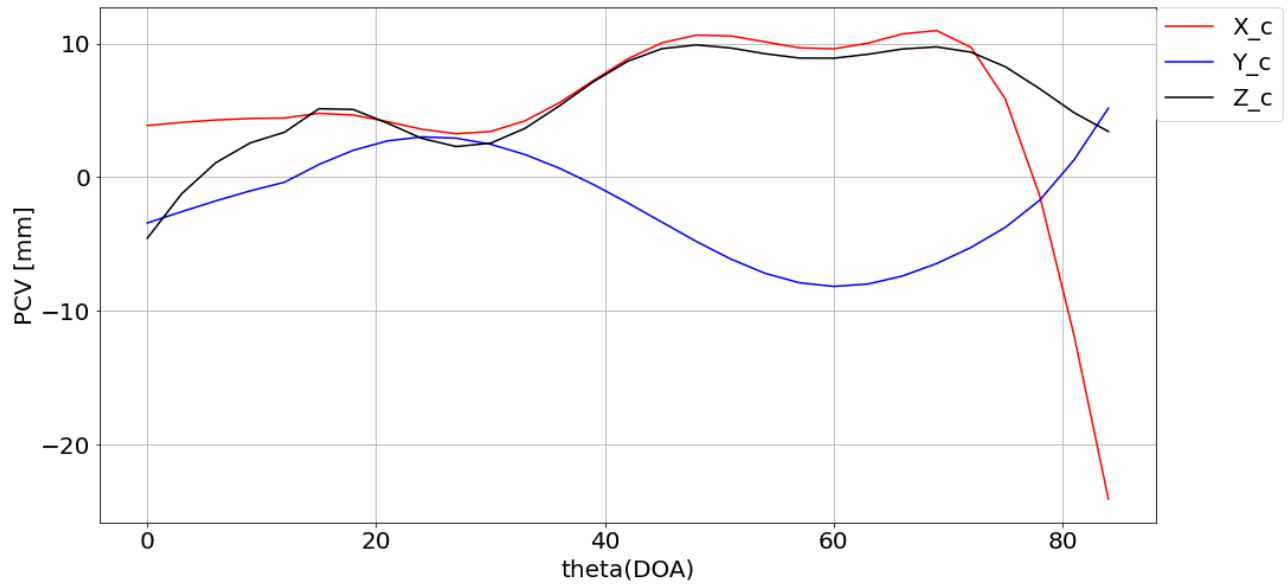

L2 band

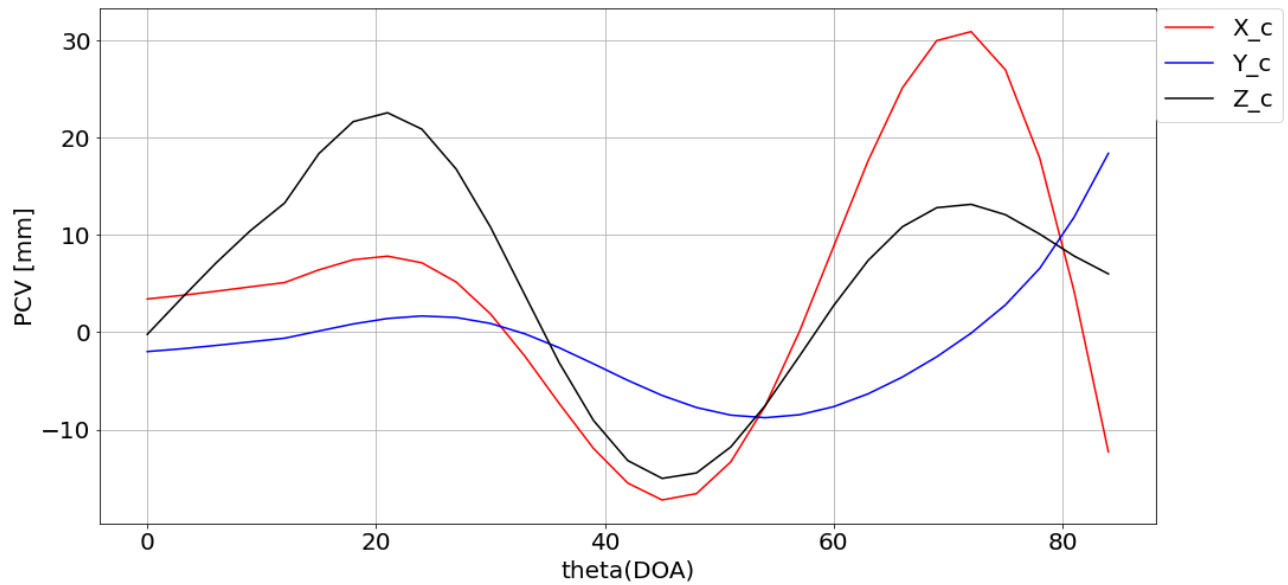

L5 band

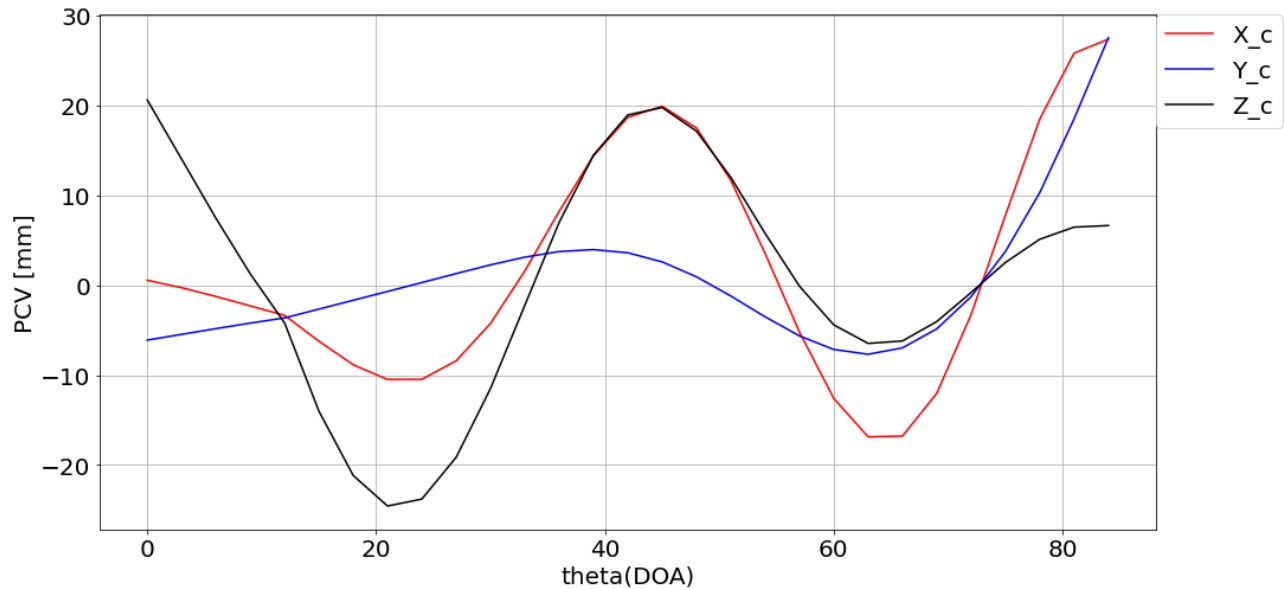

Rooftop Testing

For this test Maxtena used u-blox ZED-F9P receiver. Receiver was flashed with the latest firmware version. The test was performed in an open sky environment for 24 hours. Measurements were done without ground plane under the antenna.

Receiver features

- Receiver supports the GNSS and their signals as follows: GPS L1C/A L2C, GLO L1OF L2OF, GAL E1B/C E5b, BDS B1I B2I, QZSS L1C/A L1S L2C, SBAS L1C/A
- Horizontal position accuracy RTK= 0.01 m + 1 ppm CEP
- Vertical position accuracy RTK= 0.01 m + 1 ppm CEP
- Navigation update rate RTK up to 20 MHz

Positioning Accuracy					
Test Conditions	Correction Service	CEP (50 %)	DRMS (68 %)	2DRMS (95-98.2 %)	TTF (sec)
Free space	RTK	0.66 cm	0.66 cm	1.3 cm	99.6

RTK Availability

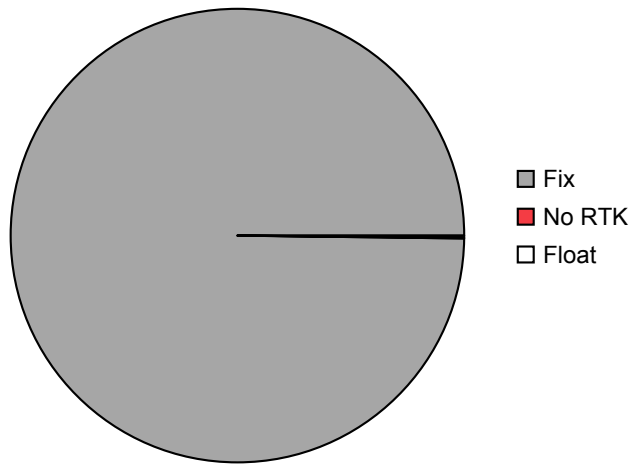

8 7 6 5 4 3 2 1

DRAWING REVISION HISTORY			
REV	DESCRIPTION	DATE	BY
A	INITIAL RELEASE	2023-04-25	MP

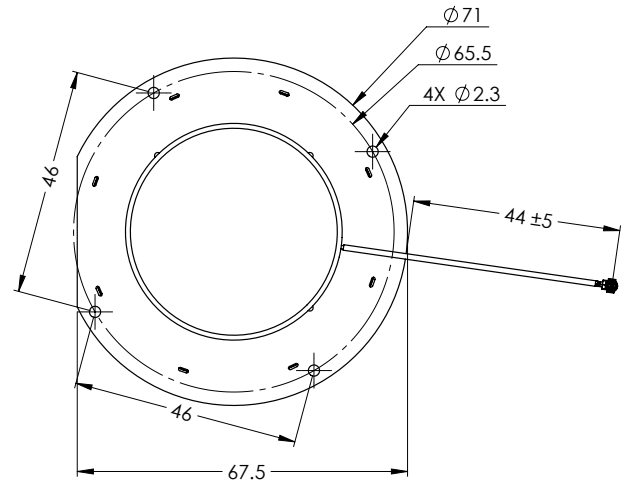
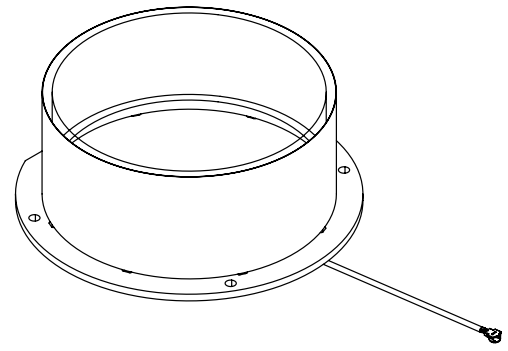
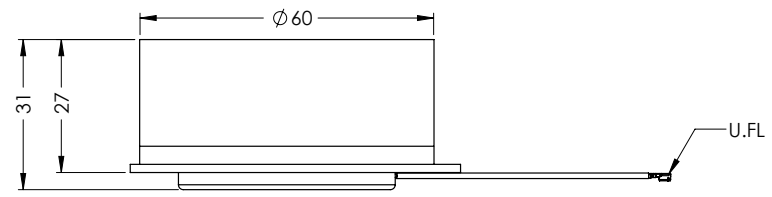
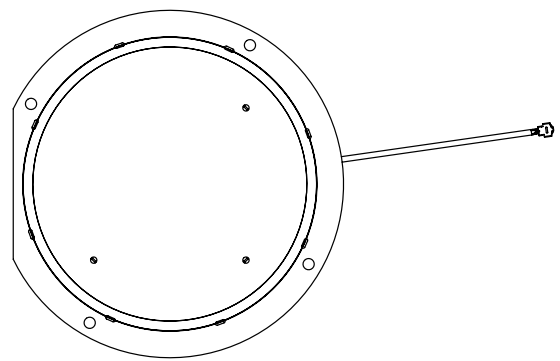

NOTES:

- ATTACHMENT METHOD - FOUR #2-56 SCREW MOUNTING HOLES
- CONNECTOR: U. FL

ITEM 180-00090-02 REVISION HISTORY			
REV	DESCRIPTION	DATE	BY
1	INITIAL RELEASE	2023-04-25	MP

PROPRIETARY AND CONFIDENTIAL

THE INFORMATION CONTAINED IN THIS DRAWING IS THE SOLE PROPERTY OF MAXTENA, INC. ANY REPRODUCTION IN PART OR AS A WHOLE WITHOUT THE WRITTEN PERMISSION OF MAXTENA, INC IS PROHIBITED.

UNLESS OTHERWISE SPECIFIED:	NAME	DATE
DIMENSIONS ARE IN MM	DRAWN MP	2023-04-25
TOLERANCES:	CHECKED ZX	2023-04-26
FRACTIONAL ±	ENG APPR. NPC	2023-04-28
ANGULAR: MACH ± .5° BEND ±	MFG APPR.	
ONE PLACE DECIMAL ± 1.0	Q.A.	
TWO PLACE DECIMAL ± .50		
INTERPRET GEOMETRIC TOLERANCING PER:		
THIRD ANGLE PROJECTION		
DO NOT SCALE DRAWING		

MAXTENA, INC		TITLE:	REV
180-00090-02		117-00713-01	1
M10HCT-A- EMB		SIZE DWG. NO.	
CAGE CODE: 5KQH7		SCALE: NONE	SHEET 1 OF 1

8 7 6 5 4 3 2 1