



Application Note

GPS Passive Patch Antennas

Maxtena Proprietary Information, Version 1.2, Revised 11/13



This document applies to the following product(s):
GPS Passive Patch Tuning Kits
GPS Passive Patch Embedded Antennas



GENERAL CONSIDERATIONS

Microstrip patch antennas have several well-known advantages over other type of antennas: they are low profile, light weight, low cost, mechanically robust, and compatible with microwave monolithic integrated circuits (MMICs). Because of these merits, microstrip patch antennas have been utilized in many applications such as mobile communication base stations and satellite communication systems. However, it is important to note that, despite the previously mentioned features, they suffer from several inherent disadvantages. Namely, they have small bandwidth (a single-patch microstrip antenna with a thin substrate, thickness less than 0.02 free-space wavelength, generally has a narrow bandwidth of less than 5%) and their pattern and radiation efficiency is heavily dependent on the size of the ground plane they are installed on.

The relative simplicity in generating circular polarization and the low cost are the main reasons why microstrip patch antennas have been widely utilized for satellite communications and GNSS applications.

Principles of operation

Microstrip patch antennas consist of a metal patch on a grounded substrate. The patch radiates from fringing fields around its edges, and its pattern maximum is at broadside. For impedance matching purposes, the patch can be modeled as a resonant cavity. At the resonance frequency the radiation resistance dominates the real part of the impedance. The reactance can be minimized by properly positioning the feeding pin and the antenna achieves peak efficiency. Without proper matching, little power radiates. The length of the patch (non radiating edges) is typically $\lambda_g/2$ (where λ_g is the wavelength inside the substrate).

This means that the smaller is the patch (if the dielectric constant and the thickness of the substrate do not change) the higher is the operating frequency. Thicker substrates deliver greater bandwidth, but they increase the possibility of higher-order mode excitation and surface-wave losses. As the thickness is reduced, the losses increase significantly and the total efficiency degrades to a point where the bandwidth remains constant.

Patches are usually manufactured by etching or metal deposition techniques on a low loss dielectric or ceramic substrate. The substrate generally has a thickness in the range of 0.01–0.05 free-space wavelength (λ_0). It is used primarily to provide proper spacing and mechanical support between the patch and its ground plane. For GPS applications high dielectric-constant material is used to load the patch and reduce the size. However, higher dielectric constant translates in smaller antenna volume and significantly reduce the bandwidth.

Ideally, the dimensions of the substrate and the ground plane should be several wavelengths long to achieve the best performances from a microstrip patch antenna. In practice, they are usually comparable to the size of the metallic patch. It is important to understand how the patch performances vary in relation to the size of the ground plane to their relative position.



Figure 1 - Maxtena ceramic patch antennas.



MAXTENA CERAMIC PATCH ANTENNAS

Maxtena offers five different ceramic patch GPS antennas (see Fig. 1). Each antenna has different size and characteristics, which are summarized in the following table:

	MPA-104	MPA-124	MPA-154	MPA-184	MPA-254
Size (mm)	10x10x4	12x12x4	15x15x4	18x18x4	25x25x4
Efficiency	45%	50%	70%	70%	80%
Polarization	RHCP	RHCP	RHCP	RHCP	RHCP
Realized Gain	2 dBic	3 dBic	4 dBic	4.5 dBic	5 dBic
Axial Ratio	1.5 dB (typical) 2.5 dB (max)	1.5 dB (typical) 2.5 dB (max)	1.5 dB (typical) 2.5 dB (max)	1.5 dB (typical) 2.5 dB (max)	1.5 dB (typical) 2.5 dB (max)
Bandwidth (-1dB)	10 MHz	10 MHz	10 MHz	16 MHz	20 MHz
CP Rejection	15 dB (typical) 10 dB (min)	15 dB (typical) 10 dB (min)	15 dB (typical) 10 dB (min)	15 dB (typical) 10 dB (min)	15 dB (typical) 10 dB (min)

It is important to note that these characteristics have been measured placing the patches in the middle of a 3X3 in (76X76 mm) ground plane. When the patches are mounted in different positions or on a different size ground plane, their performances are subject to change.



GROUND PLANE SIZE EFFECTS

In the following, the effects of a change in size of the ground plane are examined, by means of a software simulation, for a 18X18X4 mm patch antenna (see Fig. 2), tuned to operate in the GPS L1 band. This antenna has the following characteristics when simulated on 3X3 in ground plane:

Efficiency	Realized Gain	Axial Ratio	Bandwidth (-1dB)	CP Rejection	Frequency
80%	4.7 dBic	1 dB	13 MHz	20 dB	1576 MHz

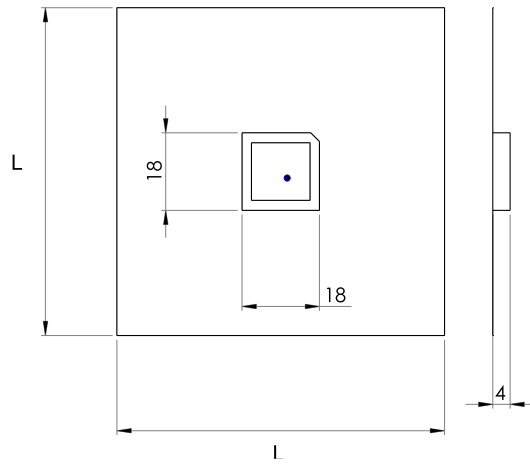

Figure 2 - Drawing of the patch with the relevant dimensions (mm).

When the ground plane size changes the resonance frequency of the patch, where the matching is optimal, changes as well. In Fig. 3(a) the frequency where the peak gain occurs is reported as a function of the ground plane size L . The length L spans from 18mm to 76mm. It can be noted that as the ground plane size varies the center frequency changes significantly. As a result, the patch is not tuned anymore at the nominal frequency (1576 MHz). All the other characteristics will change accordingly. In particular, while the bandwidth has less than 10 MHz variation (see Fig. 3(b)), the RHCP gain drops from 4.7 dBic to almost -3 dBic (see Fig. 4(a)), when L varies from 76mm to 18 mm, which is the actual size of the patch substrate. To fully understand the effect of the variation of ground plane size on the patch radiation characteristics it is important to properly define the difference between the nominal frequency, in this case 1576 MHz, and the actual peak or center frequency. If a patch is tuned to work at a specific nominal frequency on a reference ground plane, when installed on a different ground might produce a peak gain at a different frequency. As a result the response at the desired nominal frequency might be severely degraded, but the overall radiation characteristics might still be acceptable at the actual center frequency.

To properly estimate the extent of the degradation on performance linked to a smaller ground plane and derive possible remedies it is useful to track the key performance metrics both at the nominal frequency and actual center frequency. Fig. 4(b), for instance, summarizes the behavior of the radiation efficiency as the size of the ground plane decreases at the nominal and center frequencies. The nominal frequency is 1576 MHz, which is the design frequency on a 3X3 in ground plane, and at the actual center frequency varies as in Fig. 3(a). It is worth noting that a change in size of the ground plane drastically deteriorate the performances of the patch at 1576 MHz. However, if the patch is tuned again for each value of L , this degradation can be mitigated. In Fig. 5(a) the directivity is shown: it follows a similar trend.

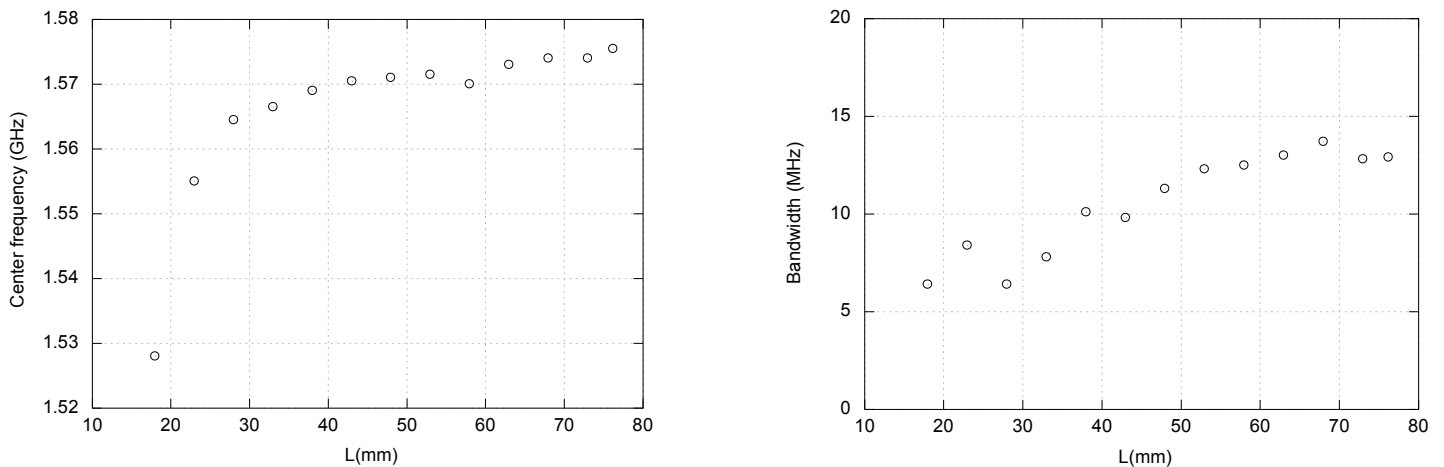

Figure 3 - (a) Center frequency and (b) bandwidth as a function of the length L .

The ground plane size variation has also depolarization effects. In Fig. 5(b) the axial ratio is reported as a function of the length L. It can be noted how the axial ratio quickly increases as L decreases if the patch is not properly tuned.

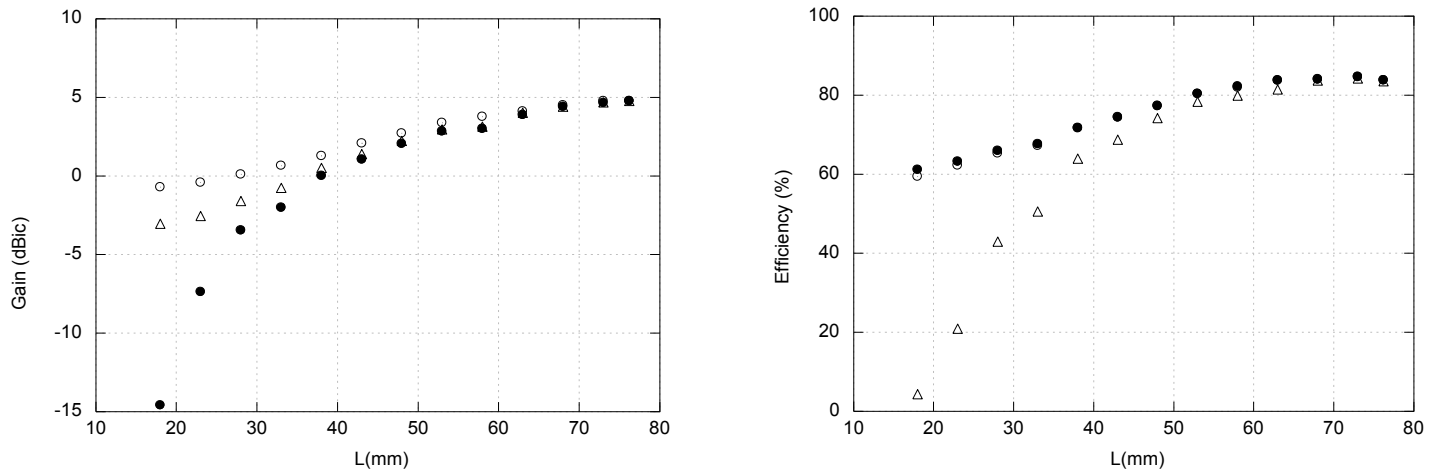

Figure 4 - (a) RHCP gain as a function of the length L. (b) Efficiency as a function of the length L. Legend: white dots: realized gain/radiation efficiency at center frequency; triangles: gain/radiation efficiency at 1576 MHz; black dots: realized gain/total efficiency at 1576 MHz.

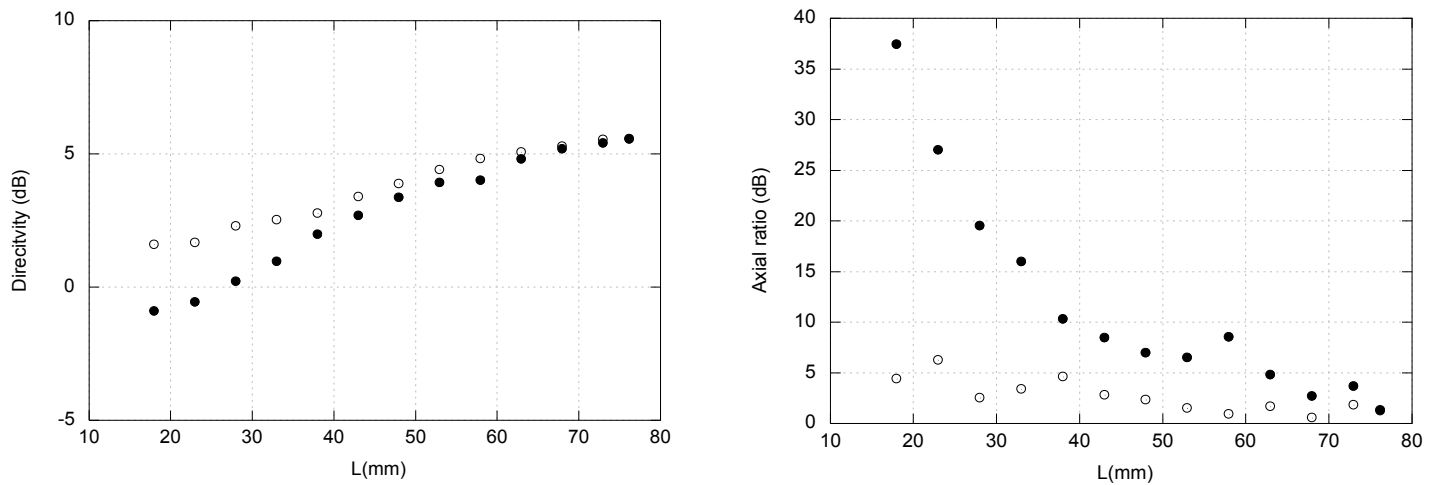

Figure 5 - (a) Directivity and (b) axial ratio at 1576 MHz a function of the length L. Legend: white dots: directivity/axial ratio at center frequencies; black dots: directivity/axial ratio at 1576 MHz.

Positioning

The position of the patch on top of the ground plane has effects on the radiation properties of the antenna similar to a variation of the size L. In the following some results are reported for the patch moving on the diagonal of the ground plane, starting from the center (see Fig. 6). Results are reported in Figs. 7, 8, and 9. While efficiency and bandwidth are barely sensitive to the patch position, unless the patch is really close to the edge of the ground plane, the peak gain and the cen-

ter frequency vary significantly. The dominant effect is depolarization. As it is shown in Fig. 7, the axial ratio at 1576 MHz increases from 1 dB to 20 dB, as the patch is moved.

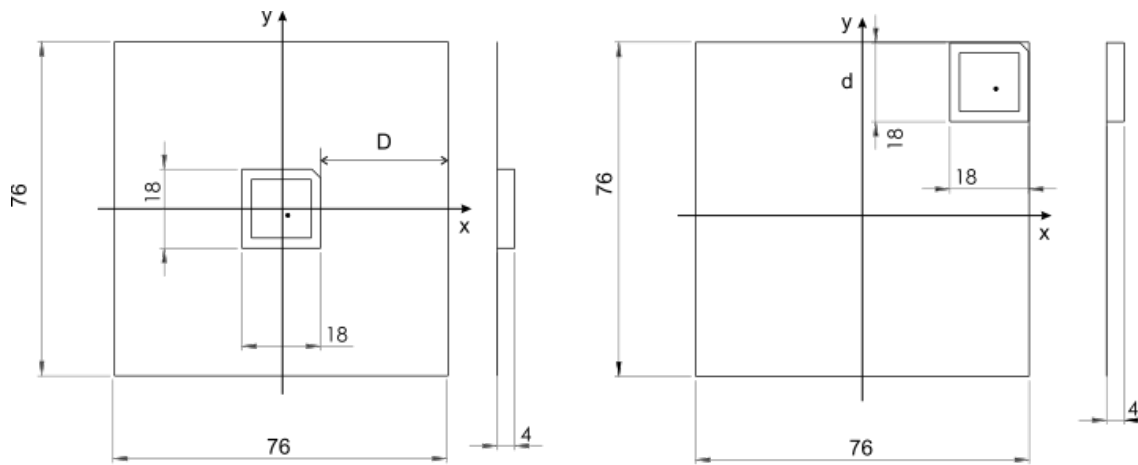

Figure 6 - Drawing of the patch on a 76X76 mm ground plane, with the relevant dimensions (mm). Distance from the edge of the ground plane (a) $D = 29$ mm, (b) $D = 0$ mm.

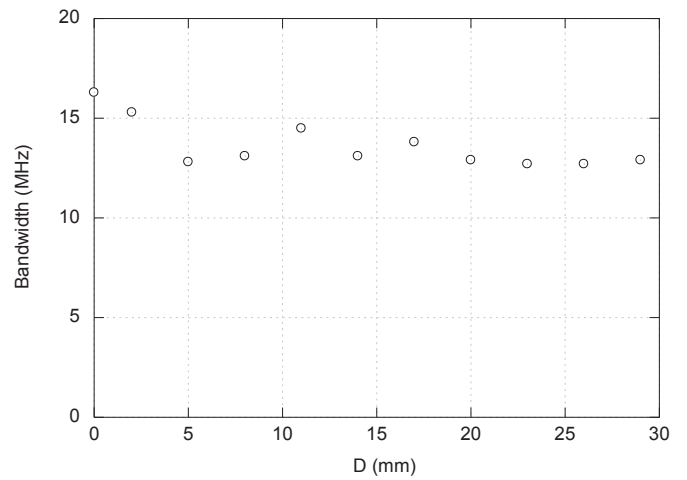
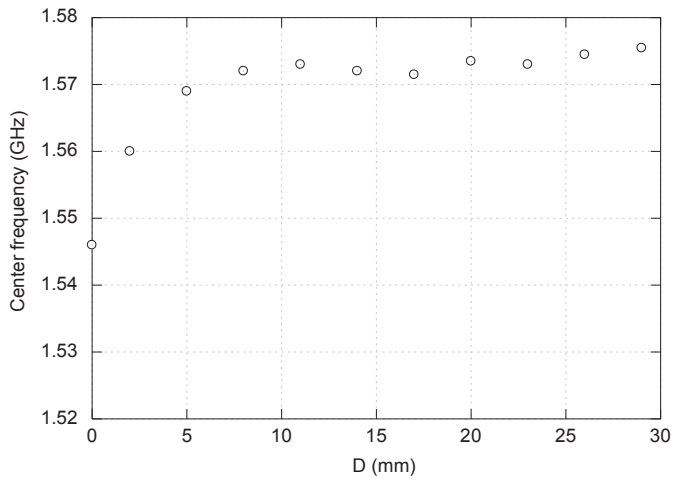

Figure 7 - (a) Centre frequency and (b) bandwidth as a function of the distance d from the center of the ground plane.

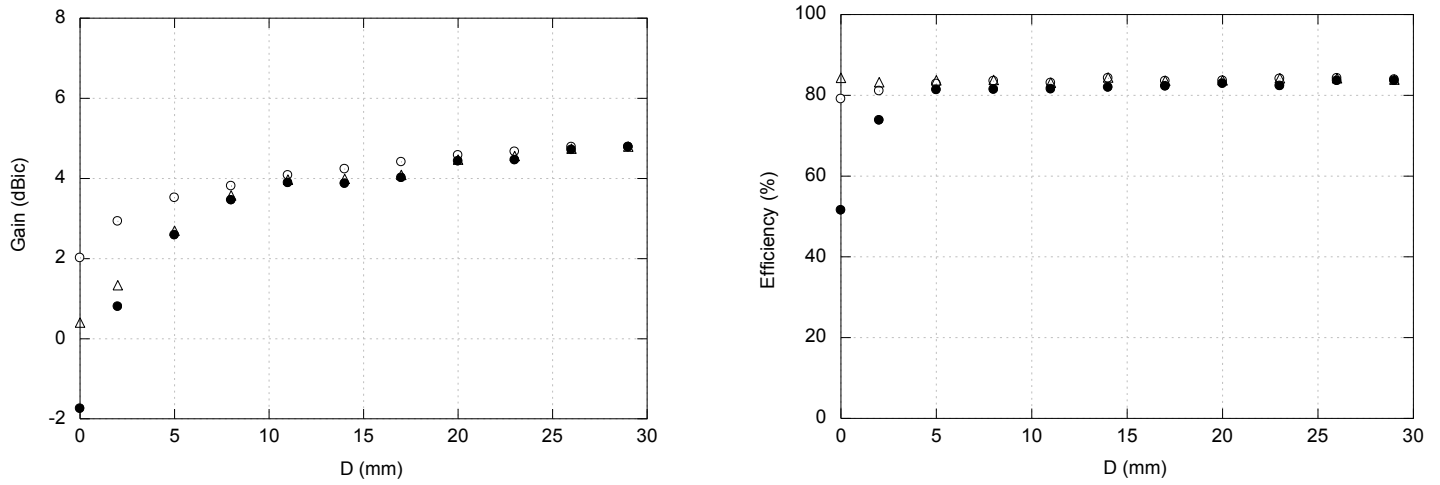

Figure 8 - (a) RHCP gain as a function of the distance d from the center of the ground plane. (b) Efficiency as a function of the length L . Legend: white dots: realized gain/radiation efficiency at center frequency; triangles: gain/radiation efficiency at 1576 MHz; black dots: realized gain/total efficiency at 1576 MHz.

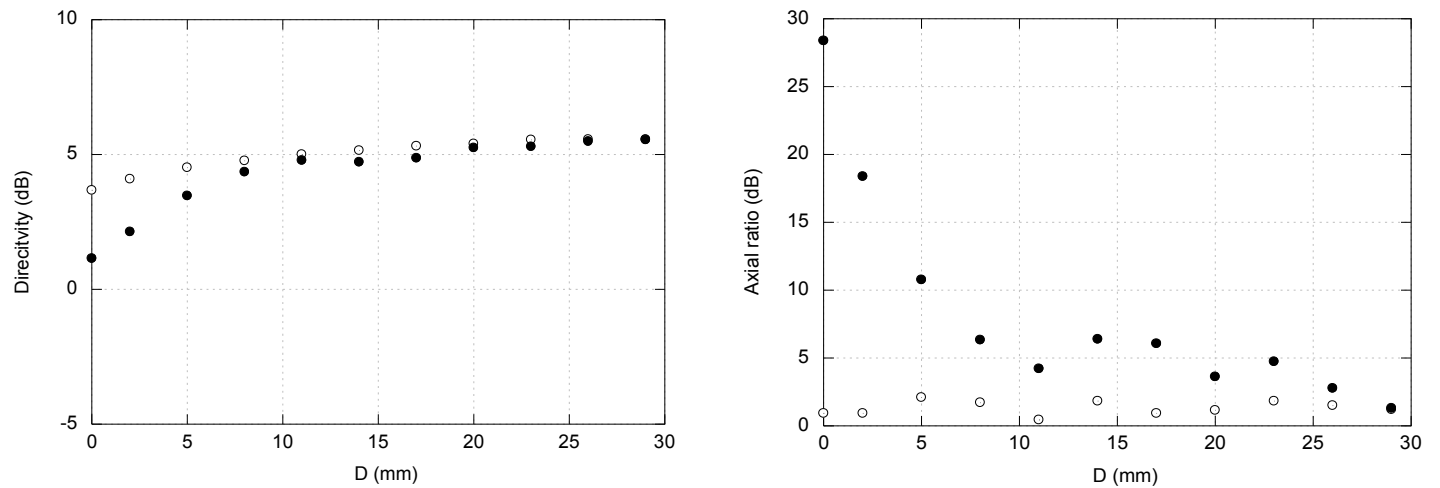

Figure 9 - (a) Directivity and (b) axial ratio at 1576 MHz a function of the distance d from the center of the ground plane. Legend: white dots: directivity/axial ratio at center frequencies; black dots: directivity/axial ratio at 1576 MHz.

MOUNTING

All patches are mounted using double sided adhesive tape. A suitable ground area has to be cleared on the device board. The pin goes through to the bottom side of the board where it is soldered to the feedline. Fig. 10 describes the suggested layout for the feed and ground areas. The ground area shown in Fig. 10 is suggested for a 18 mm patch. If a patch of different size is considered, the ground area dimensions should be changed to match the size of the patch.

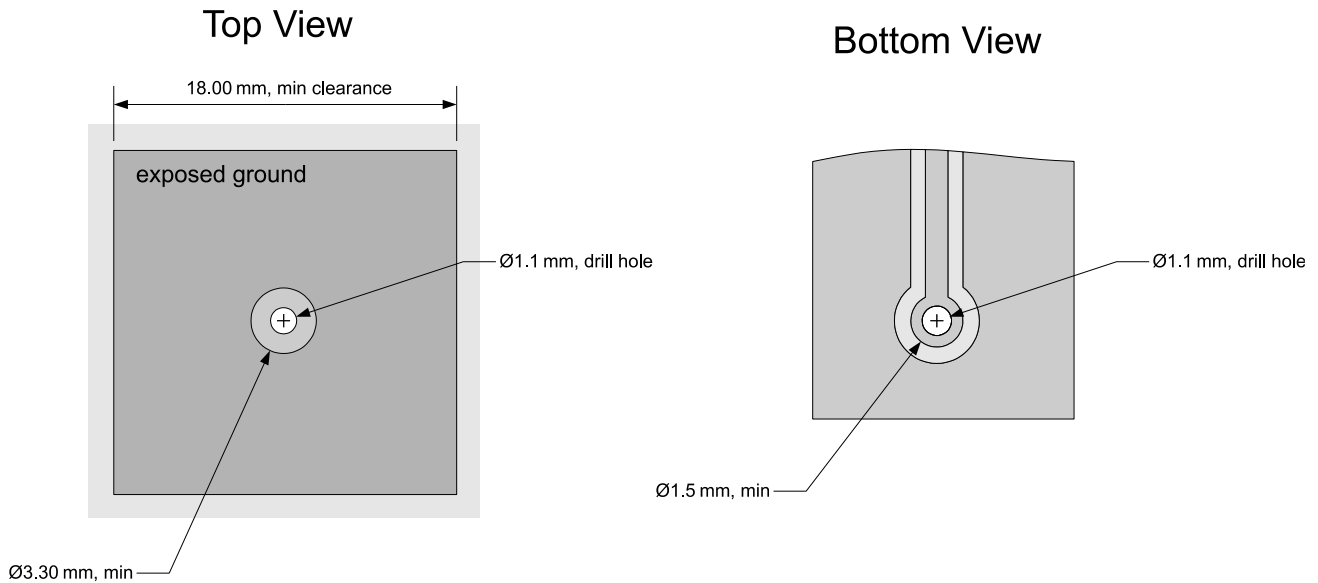

Figure 10 - Mounting footprint.

HOW TO ESTIMATE PATCH PERFORMANCE IN A PRACTICAL IMPLEMENTATION

The previous sections provide a systematic analysis of the effect of different ground configurations on the performance of a ceramic patch. The most important question from a practical point of view is how to use the information contained in the previous sections to estimate the gain, axial ratio and efficiency that can be achieved in a real implementation on a non-ideal-ground plane.

Let's consider a simple example to illustrate how the plots in the sections above can be used for this purpose. Let's assume that a patch of 18X18mm is selected for a specific GPS application. The patch is tuned in a specific factory set-up, usually a 76mm X 76 mm ground, to provide peak performance at 1575 MHz.

In the specific application considered, however, the patch is mounted on a large ground but 2 mm from the edge. From Fig. 7(a) it can be estimated that the patch gain will be maximum at about 1550 MHz. The peak gain at 1550 MHz is about 2.5 dBic, as indicated in Fig 8(a). By Fig. 8(b) and Fig. 9(b) it can also be concluded that efficiency and axial ratio are nominal at 1550 MHz, thus indicating good polarization discrimination is preserved. However at 1575 MHz, the desired operating frequency, the peak gain is only -2 dBic and polarization is completely compromised as indicated by the high value of the axial ratio in Fig. 9(b) (Black dots).

On the other hand the previous analysis shows that if the patch was pre-tuned to provide peak performance as installed on the actual device, the overall gain at 1575 MHz can be improved of 4.5 dB. To address the need for pre-tuned samples, Maxtena offers tuning kits, described in the next section.

From a practical point of view, the most important effect of varying the size of the ground plane or the relative position of the patch on the ground is a shift in the resonant frequency. In general, the results described in the previous sections demonstrate that the closer the patch is to the edge of the ground the lower is the resonant frequency. Proximity to the edge could either be due to a reduced ground size or to an offset of the antenna position. The general trend is the same. The dramatic degradation in performance described in the previous section is mostly due to the fact that the antenna is optimized at the nominal tuning frequency, when installed on a 3X3 inches ground plane. If the key metrics, such as axial ratio and peak RHCP gain are plotted at each of the effective resonant frequencies, resulting from the edge proximity effect, the degradation in performance is not as significant.

The results illustrated in figures 4(a) and 4(b) suggest that for a specific application best performances are achieved if the patch is tuned to resonate at the correct frequency when installed in the intended position and ground structure. Unfortunately, commercially available patches are tuned on a reference ground and there is no guarantee that they are going to resonate at the same frequency when embedded in an actual device.

To provide customers with an inexpensive, quick and effective way to determine the correct patch tuning for their specific applications, Maxtena offers tuning kits.

Each tuning kit includes 10 patches (see Fig. 11) tuned at slightly different frequencies. Since the effect of dielectric loading and edge proximity produces a downward shift of the center frequency, the tuning kits contain patches tuned on the reference ground plane at incrementally higher frequency than the nominal GPS L1 center frequency.

The customer can install different patches on the target device and determine which variation provides optimal performance. At the moment of placing the order for production quantities the customer can specify the desired nominal frequency determined with the tuning kit and Maxtena will deliver products tuned accordingly.



Figure 11 - Maxtena tuning kits. From left to right, MPA-GPS-10, MPA-GPS-12, MPA-GPS-15, MPA-GPS-18, MPA-GPS-25

© Copyright 2013 Maxtena Incorporated. All rights reserved. All registered marks, trademarks, service marks and logos are property of their respective holders. Information is subject to change without notice.